

Canon

550EX  
SPEEDLITE

# Canon

# SPEEDLITE 550EX



E

E

English Edition  
INSTRUCTIONS

# Thank you for purchasing a Canon product.

The Canon Speedlite 550EX is a powerful, high-output flash unit featuring E-TTL (Evaluative-Through-The-Lens) autoflash control. It can be used as an on-camera Speedlite or as a master or slave unit in a wireless, multi-Speedlite system.

When used with Type-A cameras (listed below), the 550EX obtains natural-looking flash pictures by balancing the flash output and existing light. The 550EX also enables high-speed sync (FP or Focal-Plane flash), FE (Flash Exposure) lock, FEB (Flash Exposure Bracketing), bounce flash and area AF-assist.

When used with Type-B cameras (listed below), the 550EX works as a TTL autoflash unit.

With Type-B cameras, some 550EX features are not available. Refer to the tables below to check your camera type and the features available.

This Instructions booklet has separate sections for Type-A and Type-B cameras. Read the section which applies to your camera.



Type-A Camera	E-TTL	EOS-1D, 1V, 3, D60, D30, ELAN 7/7E, 30/33, 50/50 E, ELAN II/ELAN II E, 300/REBEL 2000, 500N/REBEL G, 3000N/66/REBEL XSN, IX, IX 7/IX Lite
Type-B Camera	TTL	All other EOS cameras.

## 550EX Features Available with EOS Cameras

○: Available X: Not available

Features	With Type-A Cameras	With Type-B Cameras
E-TTL autoflash control	○	X
High-speed sync (FP flash)	○	X
FE lock	○	X
FEB	○	○
Wireless, multi-Speedlite E-TTL	○	X

### Key to Symbols

-  : Warning for preventing camera or Speedlite malfunction.
-  : Supplementary notes for basic operation.
-  : Helpful tip for Speedlite operation or picture taking.
- Keep this Instructions booklet handy for future reference.

## Conventions Used in this Booklet

The Instructions are divided into separate sections for Type-A and Type-B cameras. If you have a Type-A camera, see pages 10 to 76 and 112 to 125. If you have a Type-B camera, see pages 10 to 22 and 77 to 125.

- The Speedlite operation procedures assume that the Speedlite 550EX has been turned on with its main switch. Before proceeding, turn on the main switch.
- The camera and Speedlite's buttons and dials and their settings are indicated by icons in the Instructions. The name of each button and dial can be found in "Nomenclature" on page 6. Icons for camera modes are also used. They are as follows:

 : Full Auto

**P** : Program AE

**Av** : Aperture-priority AE

**Tv** : Shutter speed-priority AE

**M** : Manual

- The **CF** icon indicates a simple explanation of a relevant Custom Function. For details, see "Custom Functions" on page 112. The Custom Function explanations assume that the default Custom Function settings are in effect.

# Contents

		Nomenclature .....6
	<b>Before You Start</b>	1. Installing Batteries.....10 2. External Power Sources .....12 3. Attachment to Camera .....13 4. Wireless Selector .....14 5. Main Switch.....16
<b>For Type-A Cameras</b>	<b>Basic Flash Photography</b>	1. Using Flash in Full Auto Mode .....24 2. Using Flash in Other Camera Modes .....26
	<b>Advanced Flash Photography</b>	1. High-Speed Sync (FP Flash) .....32 2. FE Lock.....34 3. Flash Exposure Compensation .....36
	<b>Wireless Flash Photography</b>	[1] <b>Wireless System Setup and Testing</b> ...52 1. Setting the 550EX as the Master Unit ....52 2. Setting the 550EX as a Slave Unit.....53 3. Setting the Master/Slave Channel .....54 4. Setting the Slave ID .....56 5. Master Flash ON/OFF .....57 6. Wireless Flash Range.....58
<b>For Type-B Cameras</b>	<b>Basic Flash Photography</b>	1. Using Flash in Full Auto Mode .....78 2. Using Flash in Other Camera Modes .....80
	<b>Advanced Flash Photography</b>	1. Flash Exposure Compensation .....86 2. FEB (Flash Exposure Bracketing) .....88 3. Bounce Flash .....90
	<b>Wireless Flash Photography</b>	[1] <b>Wireless System Setup and Testing</b> ...100 1. Setting the 550EX as the Master Unit....100 2. Setting the 550EX as a Slave Unit.....100 3. Setting the Master/Slave Channel .....101 4. Setting the Slave ID .....103 5. Master Flash ON/OFF .....104 6. Wireless Flash Range.....105

- For Type-A cameras, see pages 10 to 76 and 112 to 125.
- For Type-B cameras, see pages 10 to 22 and 77 to 125.

6. Pilot Lamp and Test Firing.....17	10. Setting the Film Speed .....21
7. Flash Exposure Confirmation .....18	11. LCD Panel Illumination .....21
8. Using the Zoom Button and Wide Panel .....18	12. AF-Assist Beam .....22
9. Flash Mode .....21	Automatic Reversion to Default Settings.....22
(1) <b>Av</b> : Aperture-Priority AE and E-TTL Autoflash.....27	(3) <b>M</b> : Manual Exposure and E-TTL Autoflash.....30
(2) <b>Tv</b> : Shutter Speed-Priority AE and E-TTL Autoflash .....29	
4. FEB (Flash Exposure Bracketing) .....38	7. Manual Flash Mode .....44
5. Bounce Flash.....40	8. Stroboscopic Flash .....46
6. Close-Distance Flash Photography .....43	9. Second-Curtain Synchronization .....49
[2] Wireless E-TTL Autoflash .....60	10. Modeling Flash .....50
1. Wireless E-TTL Autoflash With Flash Ratio OFF .....60	2. Wireless Manual Flash With Varied Flash Output.....72
2. Wireless E-TTL Autoflash With Flash Ratio ON .....63	[4] Wireless Stroboscopic Flash .....73
[3] Wireless Manual Flash .....71	[5] Manual or Stroboscopic Flash With a Slave Unit .....74
1. Wireless Manual Flash With Uniform Flash Output .....71	1. Setting Manual Flash With a Slave Unit .....74
(1) <b>Av</b> : Aperture-Priority AE and E-TTL Autoflash.....81	2. Stroboscopic Flash With a Slave Unit ...75
(2) <b>Tv</b> : Shutter Speed-Priority AE and E-TTL Autoflash .....83	(3) <b>M</b> : Manual Exposure and E-TTL Autoflash.....84
4. Close-Distance Flash Photography .....92	6. Stroboscopic Flash .....95
5. Manual Flash Mode .....93	7. Second-Curtain Synchronization...98
[2] Wireless Manual Flash ...107	1. Manual Flash With a Slave Unit.....110
1. Wireless Manual Flash With Uniform Flash Output .....107	2. Stroboscopic Flash With a Slave Unit ...111
2. Wireless Manual Flash With Varied Flash Output ..108	Custom Functions .....112
[3] Wireless Stroboscopic Flash ...109	Canon Speedlite 550EX System.....114
[4] Manual or Stroboscopic Flash With a Slave Unit ...110	Troubleshooting Guide.....116
	Specifications.....118

# Nomenclature

## ● Front

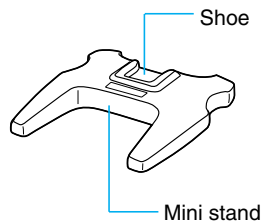
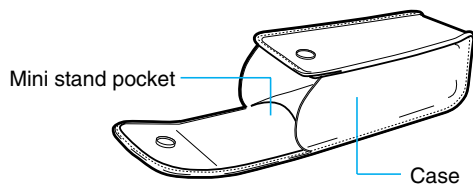
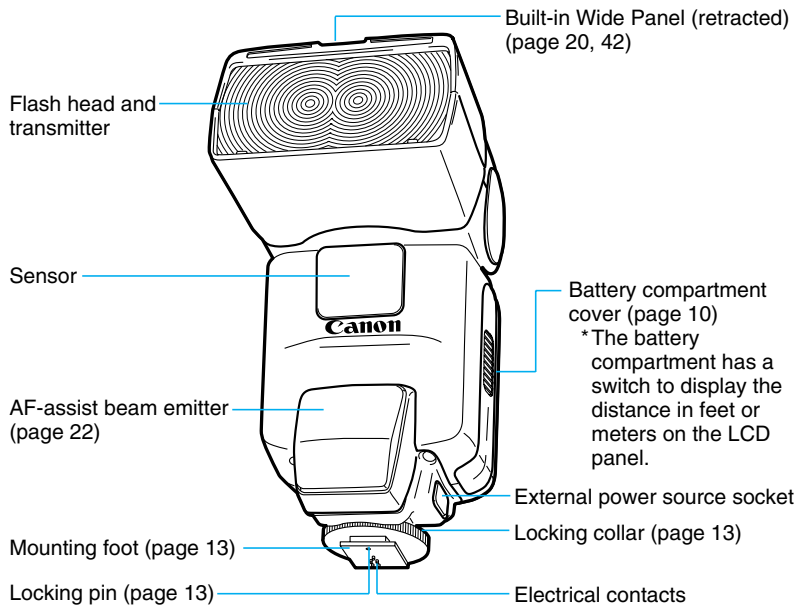



● Rear

<  > Horizontal bounce release button (page 40, 90)

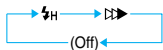
When these two buttons are pressed simultaneously, the setting changes in the following loop:



\* <  > Decrement button

\* <  > Increment button

\* <  > LCD panel illumination button (page 21)

**CF** Custom Function setting button (page 112)

< **MODE** > Flash mode and slave setting button (page 21, 74, 112)

< **PILOT** > Pilot lamp/Test firing button/Wireless slave SE cancel button (page 17, 59, 107)

Flash exposure confirmation lamp (page 18)

LCD panel

<  > Vertical bounce release button (page 40, 90)

\* < **SEL/SET** > Select/Set button

< **ZOOM** > Zoom button (page 18)

Main switch (page 16)

**O** : Turns off the power.

**I** : Turns on the power.

**SE**: Turns on the power and enables the SE mode.

Wireless selector (page 14)

< **(OFF)** > : For operation as an on-camera Speedlite.

< **MASTER** > : For operation as a wireless master unit.

< **SLAVE** > : For operation as a wireless slave unit.



Buttons marked with an asterisk remain active for 8 sec. after the button is released. LCD panel illumination with the  button remains on for 12 sec.

## ● LCD Panel

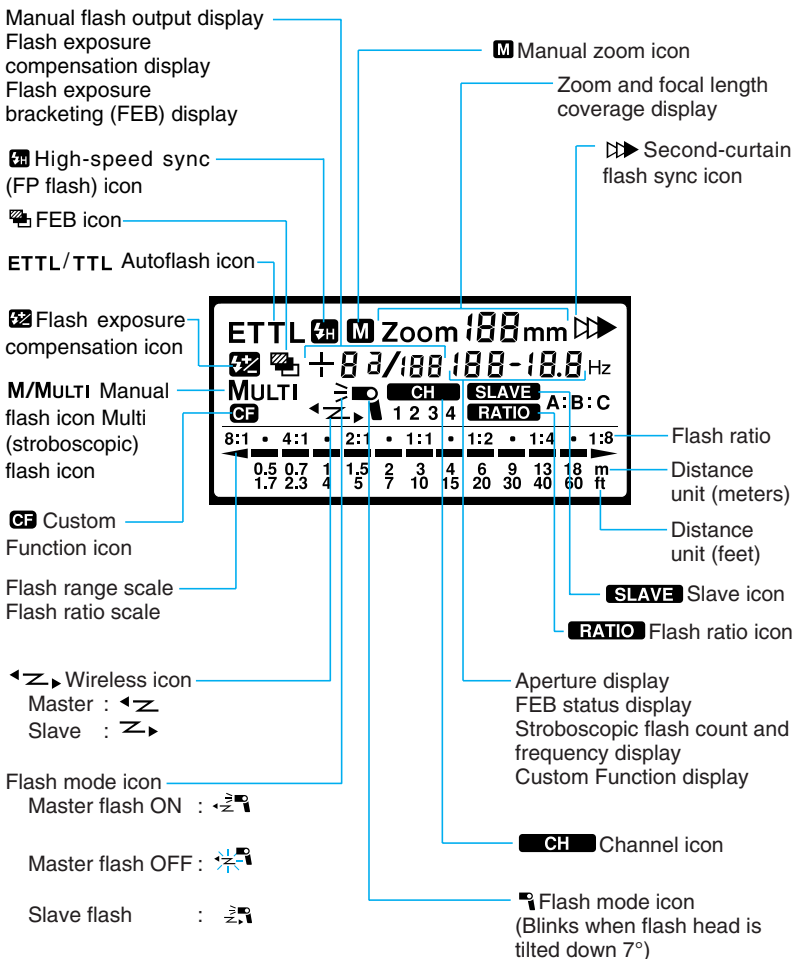



# Before You Start

This chapter is for preparing the Speedlite 550EX for actual operation.

# 1. Installing Batteries

Speedlite 550EX requires one of the following two types of batteries:

- (1) Size-AA alkaline batteries × 4
- (2) Size-AA nickel-hydride batteries × 4

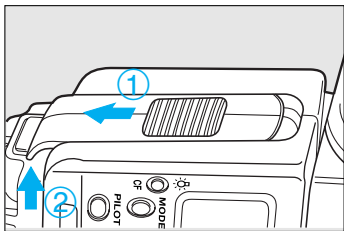

- 1** Slide the battery compartment cover as shown by the arrow and flip it up.

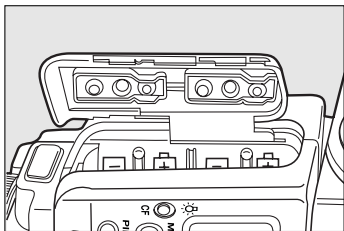

- 2** Insert the batteries with the + and - contacts oriented as shown in the battery compartment.

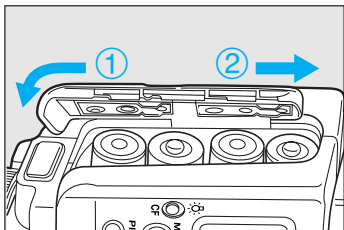

- 3** Close the battery compartment cover as shown in the figure.



- Use four new batteries of the same type. When replacing batteries, replace all four batteries at one time.
- Size-AA lithium batteries can also be used.
- Although non-alkaline, manganese batteries may also be used, the number of flashes will be less.
- Remove the batteries when the 550EX will not be used for an extended period.
- In low temperatures, take two sets of batteries and keep one set warm in a pocket, etc., and use the batteries alternately.



- To prevent faulty connections, make sure the battery contacts are clean. If necessary, use a clean cloth to wipe the battery contacts.
- In the case of size-AA nickel-hydrate and size-AA lithium batteries, the shape of the contacts is not standardized. Be sure that the batteries are compatible with the flash unit before buying.

## Recharging Time and Available Flashes

Battery Type	Recharging Time		Available Flashes
	Quick Flash	Normal Flash	
Size-AA alkaline batteries	Approx. 0.1 - 4 sec.	Approx. 0.1 - 8 sec.	Approx. 100 to 700

- The minimum recycling time applies in the E-TTL or TTL mode while the maximum recycling time applies in the manual or full-output (1/1) mode.
- The minimum flash count applies in the manual or full-output (1/1) mode while the maximum flash count applies in the E-TTL or TTL mode.
- The above specifications are based on Canon's testing standards.
- Using size-AA nickel-hydrate batteries will yield only about 70 to 80 percent of the flashes (1550 mAh at full output) obtainable with size-AA alkaline batteries. The recycling time will also be about half the time with size-AA alkaline batteries.

## 2. External Power Sources

Speedlite 550EX can use any of the following two external power sources.  
For details, refer to the Instructions of the respective external power source.

(1) Transistor Pack E

Uses Canon Battery Magazine TP (six size-C alkaline batteries) or Ni-Cd Pack TP.

(2) Compact Battery Pack CP-E2

Uses six size-AA alkaline or nickel-hydrate batteries.  
Size-AA lithium batteries can also be used.

## Recharging Time and Available Flashes

Power Source		Recharging Time (sec.)		Available Flashes
		Quick Flash	Normal Flash	
Internal Power Sources	Size-AA alkaline batteries × 4	Approx. 0.1 - 4	Approx. 0.1 - 8	Approx. 100 - 700
	Transistor Pack E (Ni-Cd Pack TP)	Approx. 0.1 - 1.5	Approx. 0.1 - 3	Approx. 300 - 1800
External Power Sources	Transistor Pack E (Size-C alkaline batteries)	Approx. 0.1 - 2	Approx. 0.1 - 5	Approx. 350 - 2200
	Compact Battery Pack CP-E2 (Size-AA alkaline batteries)	Approx. 0.1 - 1.5	Approx. 0.1 - 5	Approx. 350 - 2200



- While High-Voltage Pack E315's main switch is still on, do not clean the connector plug with water or a metal pin and do not touch the plug.
- Even when an external power source is used, batteries must be installed in the 550EX to power the internal circuitry.
- The 550EX uses both the internal and external power sources to recharge the flash. Therefore, the internal power source may become exhausted sooner than the external power source. For prolonged flash photography, keep a spare set of batteries handy for the internal power source.

### 3. Attaching the Speedlite to the Camera

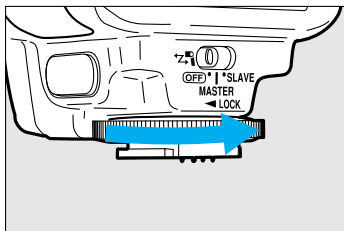

- 1 Loosen the locking collar by turning it as shown by the arrow.

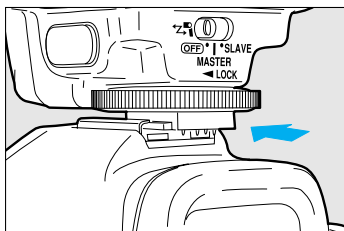

- 2 Slip the Speedlite's mounting foot into the camera's hot shoe until it stops.

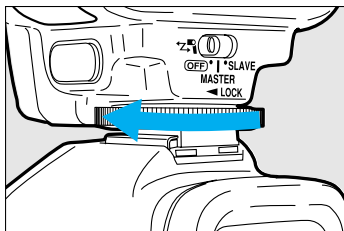

- 3 Turn the locking collar as shown by the arrow and tighten. (The mounting foot's locking pin will extend into the hot shoe.)

- To detach the Speedlite, turn the locking collar in the opposite direction until it stops. (The locking pin retracts into the mounting foot.)



Although the hot shoe on the EOS 650, EOS 620, EOS 750, and EOS 850 does not have a locking pin hole, Speedlite 550EX can still be mounted on these cameras.

## 4. Wireless Selector

---

The wireless selector has three settings as shown below.

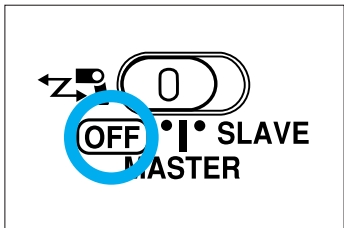

Set to OFF to use the 550EX as a normal, on-camera Speedlite.

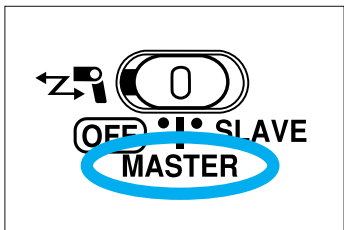

Set to MASTER to use the 550EX as the master unit in a wireless, multi-Speedlite system.

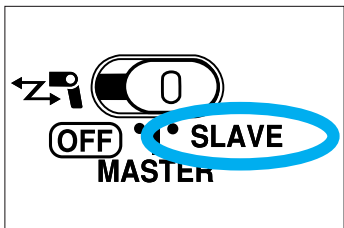

Set to SLAVE to use the 550EX as a slave unit in a wireless, multi-Speedlite system.



If the 550EX is to be used as a normal, on-camera Speedlite but the wireless selector has been set to **MASTER** or **SLAVE**, the following applies:

- MASTER** : If master flash ON has also been set, it will be the same as using the Speedlite at the wireless selector's OFF setting. If master flash OFF has been set, a picture cannot be taken.
- SLAVE** : It will be the same as using the Speedlite at the wireless selector's OFF setting. However, when the camera's exposure meter turns off 6 sec. after the shutter button is pressed, the 550EX will be a slave unit.
- If the wireless selector is set to **MASTER** and master flash OFF has been set, the flash will not fire. (see page 57)
  - When the wireless selector is set to **MASTER** or **SLAVE**, the flash coverage is set automatically to **M 24mm**. The Guide No. decreases as a result.

## 5. Main Switch

The main switch has three settings as shown below.

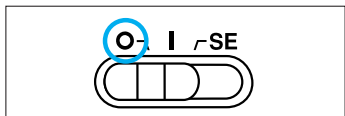

Turns off the power.

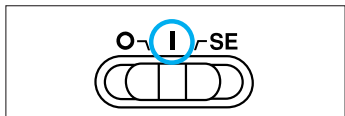

Turns on the power.

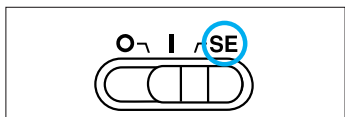

Turns on the power and enables the SE mode.

- The SE (Save Energy) mode turns off the Speedlite automatically after a period of non-use as indicated in the following table.

Wireless Selector Setting		
OFF	MASTER	SLAVE
90 sec.		60 min.

- When the wireless selector is set to **OFF** or **MASTER** and the SE mode takes effect, the LCD panel display turns off. To cancel the SE mode, either press the camera's shutter button halfway or press the Speedlite's test firing button. The Speedlite will then turn on again.
- If the wireless selector is set to **SLAVE** and the SE mode takes effect, **SE** is displayed on the LCD panel. If the time limit (1 hour or 8 hours) for turning on the Speedlite again (SE mode cancellation) elapses, **SE** turns off on the LCD panel. In this case, you must turn the Speedlite's main switch off and on again to turn it on again.

**CF** Custom Function CF-4 can alter the time it takes before the slave unit enters the SE mode. See page 113.

**CF** Custom Function CF-5 can alter the time limit for the master unit to be able to cancel the slave unit's SE mode. See page 113.



### Memory feature

The Speedlite's current mode, zoom setting, flash exposure compensation setting, etc., are retained in memory even after the Speedlite is turned off. When the Speedlite is turned on again, all the settings remain effective. When replacing the batteries, the settings stored in memory can still be retained if the new batteries are installed within one minute.



## 6. Pilot Lamp and Test Firing

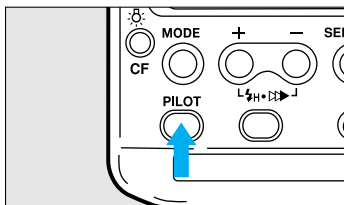
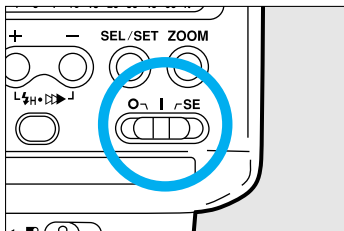

### 1 Set the Speedlite's main switch to I .

- The flash will start charging. When the flash is ready, the pilot lamp lights.

#### ● Red pilot lamp

When the flash is fully charged, the pilot lamp lights in red. For normal use, confirm that the pilot lamp is red before taking the picture.

#### ● Yellow pilot lamp

When the camera is set for single shooting, a yellow pilot lamp indicates a less-than-full charge which enables a quick flash (see description below). For close subjects which do not require full-output flash, quick flash shortens the recharging time.

### 2 To test the Speedlite, press the pilot lamp (test firing button) to fire a test flash.

### ● About Quick Flash

With the quick-flash feature, you can fire a flash even before the flash is fully charged. When the pilot lamp is yellow, a quick flash can be fired. The Guide No. for a quick flash is 1/2 to 1/16 that of a normal flash. For details, see page 121.

Quick flash cannot be fired in the following cases:

- When the Speedlite is used with a Type-B camera.
- The camera is set to continuous shooting .
- FEB is used.
- In the manual flash mode or stroboscopic flash mode with the output set to 1/1 and 1/2.
- In the stroboscopic flash mode.
- When TTL Hot Shoe Adapter 3 is used with the Speedlite.
- When Custom Function CF-3 is set to 1 (TTL autoflash).



- The Speedlite cannot be test fired during the 6 sec. after you press the camera's shutter button halfway (while exposure metering is active).
- If the Speedlite is in the SE mode, pressing the test firing button turns on the Speedlite.

## 7. Flash Exposure Confirmation

---

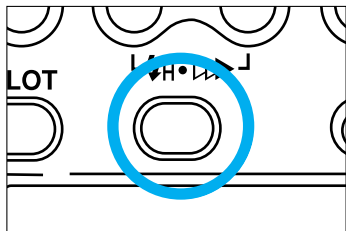

When a correct flash exposure has been obtained, the flash exposure confirmation lamp on the back of the Speedlite lights in yellow-green for 3 sec. If the flash exposure confirmation lamp does not light after the flash fires, the picture may have been underexposed. Move closer to the subject and try again.

## 8. Using the Zoom Button and Wide Panel

---

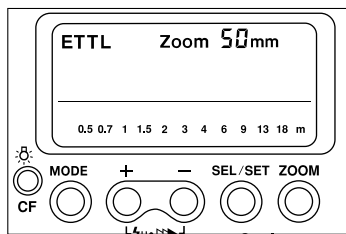

The Speedlite's flash head zooms automatically to provide adequate flash coverage for the current lens focal length. The Speedlite can provide adequate flash coverage for 24mm to 105mm lens focal lengths. If a zoom lens is zoomed, the flash head also zooms to suit the lens focal length. The flash head's zoom setting can also be set manually.

The Speedlite's built-in wide panel provides flash coverage for 17mm wide-angle lenses.

### ● Automatic Flash Head Zooming

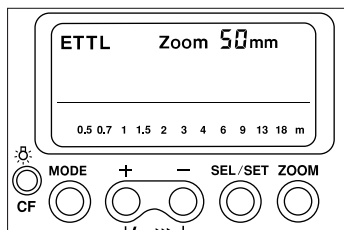

- 1 Turn on the camera.
- 2 Turn on the Speedlite.
  - If **M** is displayed, press the <ZOOM> button until **M** turns off.
- 3 Press the camera's shutter button halfway. The current lens focal length will appear on the Speedlite's LCD panel.

### ● Manual Flash Head Zooming

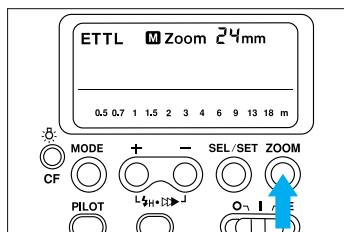

Press the <ZOOM> button. **M** and **Zoom** will be displayed. Keep pressing the <ZOOM> button until the desired zoom setting (focal length) appears. Pressing the <ZOOM> button changes the zoom setting in the loop shown below.

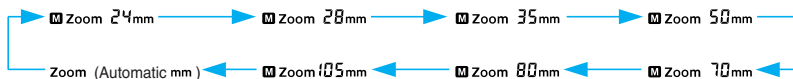

If the zoom setting is a focal length longer than the actual lens focal length, the light will fall off along the periphery of the picture.

### ● Using the Wide Panel

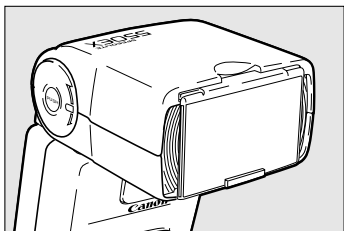

Pull out the built-in wide panel and flip it down to cover the flash head. The flash head's zoom setting will be set to 17mm automatically.

- Using the wide panel disables the <ZOOM> button.
- Use the wide panel with flash head at the normal or 7° downward tilt position.



- If the built-in wide panel is used and the flash head is turned or tilted for bounce flash, the flash result may look uneven. The LCD panel display will blink as a warning.
- Do not pull out the wide panel too hard. Otherwise, the wide panel may come off.

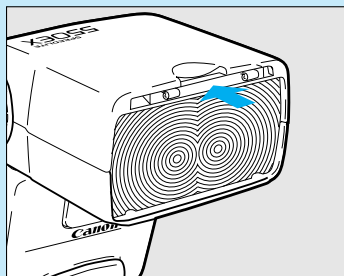

If the wide panel comes off, the <ZOOM> button will not work. If this happens, follow the procedure below.

- Use your finger to push in the panel as shown by the arrow.
- The <ZOOM> button will work again, but the entire LCD panel display will keep blinking. Take the Speedlite to the nearest Canon Service Center for repair.

## 9. Flash Mode

The following flash modes can be set with the <MODE> button: E-TTL (or TTL) autoflash, manual flash, and stroboscopic flash. Pressing the <MODE> button changes the flash mode in the following loop:

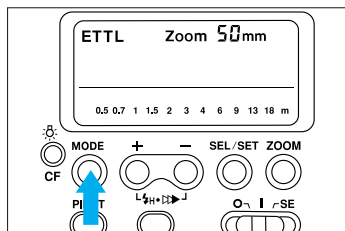

## 10. Setting the Film Speed

The film speed is set automatically according to the film speed set with the camera.

## 11. LCD Panel Illumination

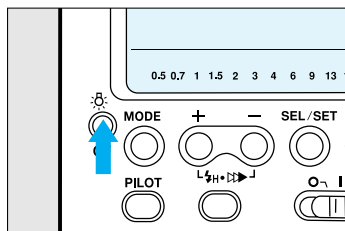

Press the <camera icon> button to illuminate the LCD panel for 12 sec. To turn off the illumination, press the <camera icon> button again.

- The illumination stays on longer than 12 sec. if you press any button other than the <PILOT> and <camera icon> buttons.

## 12. AF-Assist Beam

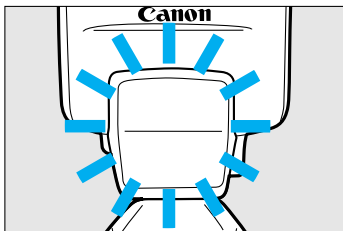

In low-light or low-contrast situations, the Speedlite emits the AF-assist beam automatically to assist autofocus. The AF-assist beam is compatible with the AF of all EOS cameras. The AF-assist beam is effective with 28mm and longer lenses. Its effective range in darkness is indicated in the table below. See page 123 for details on when the AF-assist beam is emitted.

Position	Effective Range
Center	Approx. 0.6 - 10 m / 2 - 33 ft.
Periphery	Approx. 0.6 - 5 m / 2 - 16.4 ft.

## Automatic Reversion to Default Settings

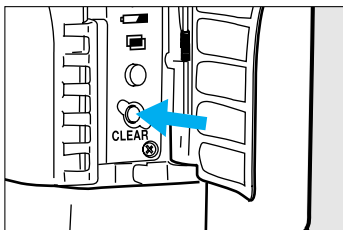

When Speedlite 550EX is attached to an EOS camera equipped with a <CLEAR> button, pressing the <CLEAR> button resets the Speedlite's settings (except the Custom Functions) to its default settings

As a Normal Speedlite	E-TTL autoflash* (All related settings are canceled.)
	Auto zoom
As a Wireless Master Unit	E-TTL autoflash* (All related settings are canceled.)
	<b>M</b> 24mm
	Master flash ON
	No flash ratio setting

\* With the EOS-1N and EOS-1, TTL autoflash takes effect.

## For Type-A Cameras

# Basic Flash Photography

When the Speedlite 550EX is attached to a Type-A camera such as the EOS-3, you can take flash pictures with E-TTL autoflash as easily as normal autoexposure (AE) pictures.

As with evaluative metering, the E-TTL autoflash system uses a multi-zone sensor. A preflash is fired for evaluative flash metering and the reading is stored in memory. Since E-TTL autoflash is linked to the active focusing point, the flash exposure is highly accurate. The result is a natural-looking flash picture with excellent balance between the flash light and ambient light.

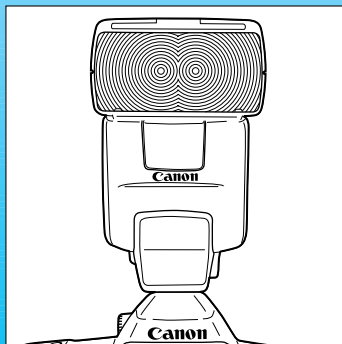

- This section assumes that the Speedlite 550EX is used with a Type-A camera.
- Before proceeding, first turn on the EOS-3 and the 550EX.
- Set the 550EX's wireless selector to OFF.
- For EOS-3 operations, refer to the EOS-3 Instructions.

# 1. Using Flash in Full Auto Mode

Set the camera's picture-taking mode to **P** (Program AE) or  (Full Auto). Flash photography will then be as easy as normal AE photography. The camera sets the aperture and shutter speed automatically to suit a wide variety of lighting conditions including outdoor fill flash. The E-TTL autoflash system sets the flash exposure automatically.

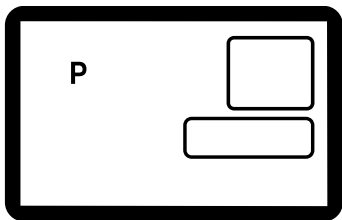

- 1 Set the camera's picture-taking mode to **P**.

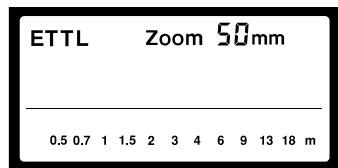

- 2 Set the 550EX's flash mode to **ETTL**.

- 3 Focus the subject.

- The shutter speed and aperture will be displayed in the viewfinder.
- The shutter speed will be set automatically at 1/60 sec. or faster (up to the top sync speed). The aperture is also set at the same time.



- 4 Check that the subject is within the flash range displayed on the 550EX's LCD panel.



- 5 Check that the  icon is displayed in the viewfinder, then take the picture.

- A preflash is fired immediately before shutter release and the main flash. The subject's meter reading is obtained with the preflash and used to set the output of the main flash. An optimum flash exposure is thereby obtained.



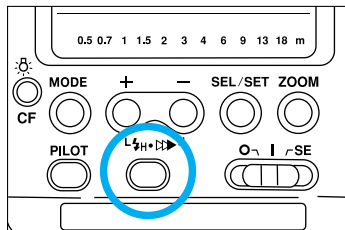

**6** After the flash fires, check that the flash exposure confirmation lamp lights.

When a correct flash exposure has been obtained, the flash exposure confirmation lamp lights for about 3 sec. If the lamp does not light, the flash may have been insufficient, resulting in underexposure. In such a case, check that the pilot lamp is red, then move closer to the subject and take the picture again.



- The preflash is fired to obtain an evaluative flash meter reading.
- The main flash illuminates the subject for the actual picture.

## ● Fill Flash

Fill flash can be used outdoors in daylight to supplement existing light. It can soften shadow areas of the subject or illuminate a backlit subject.



When fill flash is used, the flash exposure level is reduced automatically so that the subject's illumination by the flash balances well with the background's ambient light. Instead of having a properly-exposed subject and an underexposed background, both the subject and background are exposed correctly for a natural-looking flash picture.

## 2. Using Flash in Other Camera Modes

Flash photography is also automatic in the other picture-taking modes. In the **Av** (aperture-priority AE), **Tv** (shutter speed-priority AE), and **M** modes, the E-TTL autofocus system sets the flash exposure automatically. The camera sets the necessary shutter speed (in the Av mode), aperture (in the Tv mode), or flash output (in the M mode). Flash photography is as easy as normal AE picture-taking.

### Shutter Speed and Aperture Settings for Picture-Taking Modes

Camera Mode	Shutter Speed	Flash Aperture
<b>Av</b>	Automatically set (30 sec. - 1/X sec.)	Manually set
<b>Tv</b>	Manually set (30 sec. - 1/X sec.)	Automatically set
<b>M</b>	Manually set (bulb, 30 sec. - 1/X sec.)	Manually set

- Manually set: You set it yourself.
- Automatically set: Set automatically by the camera.
- 1/X sec.: Maximum sync speed. (see page 124)
- When the shutter button is pressed completely, a preflash fires to obtain an evaluative flash meter reading for setting the optimum output of the main flash.
- The background's exposure is set with the shutter speed and aperture combination.



- If the camera is set to the  mode (Full Auto), the shutter speed and aperture will be set in the same way as in the **P** mode (Program AE).
- If the **DEP** mode (depth-of-field AE) is used with the 550EX, it will be the same as using the **P** mode (Program AE).

## (1) Av: Aperture-Priority AE and E-TTL Autoflash

This mode is effective for controlling the depth of field in your flash pictures. You can also obtain a balanced exposure between the subject and background. You set the aperture and the camera sets the shutter speed automatically to obtain a correct exposure for the background. The E-TTL autoflash system obtains the proper exposure based on the aperture you set.



- 1 Set the camera's picture-taking mode to **Av**.
- 2 Set the 550EX's flash mode to **ETTL**.
- 3 Focus the subject.
- 4 Check that the subject distance is within the flash range displayed on the 550EX's LCD panel.
- 5 Check that the ⚡ icon is displayed in the viewfinder, then take the picture.



If the top sync speed display blinks, the background will be overexposed. And if the 30" shutter speed display blinks, the background will be underexposed. In such cases, change the aperture until the shutter speed display stops blinking.

### ● Balanced Flash Exposures

In low-light situations, the exposure level can be balanced between the subject and background by using a slow sync speed. You can obtain balanced flash exposures automatically by setting the camera's picture-taking mode to **Av**. The camera then sets the sync speed automatically to suit the background. Using a tripod is recommended to prevent camera shake.



Balanced flash exposure.



Flash exposure in the Full Auto mode.



- To disable automatic balanced flash exposures, set the camera's picture-taking mode to **M**. You can then set the desired shutter speed and aperture manually. See page 30.  
Based on the shutter speed and aperture you set, the E-TTL autoflash system controls the flash exposure automatically.
- If you are using the Canon EF 135mm f/2.8 soft focus lens on your camera without a tripod, setting the shutter speed and aperture manually is most effective for obtaining soft-focus effects. Follow the procedure below.
  - 1) Set an aperture near the maximum aperture.
  - 2) Set the minimum shutter speed required to prevent camera shake.
  - 3) Check that the flash has recharged, then take the picture.



- To obtain balanced flash exposures in the **Tv** mode, set the shutter speed until the meter reading indicates a correct exposure.
- To obtain balanced flash exposures in the **M** mode, set the shutter speed and aperture until the meter reading indicates a correct exposure.
- Under fluorescent lighting, the photo may have a greenish cast. And under tungsten lighting, the photo may have an orange cast.

## (2) Tv: Shutter Speed-Priority AE and E-TTL Autoflash

By selecting the shutter speed, you can obtain various effects with flash. You can set the shutter speed from 30 sec. to the top sync speed. The camera then sets the aperture automatically to obtain a correct exposure for the background. The E-TTL autoflash system controls the flash exposure based on the camera-selected aperture.

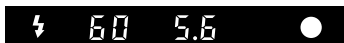
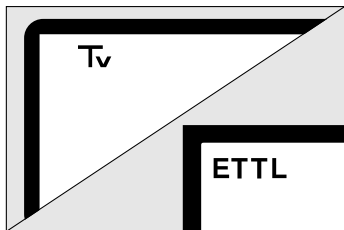

- 1 Set the camera's picture-taking mode to **Tv** and set the desired shutter speed anywhere from 30 sec. to the top sync speed.
- 2 Set the 550EX's flash mode to **ETTL**.
- 3 Focus the subject.
- 4 Check that the subject distance is within the flash range displayed on the 550EX's LCD panel.
- 5 Check that the ⚡ icon is displayed in the viewfinder, then take the picture.



If the aperture display blinks, the background may turn out overexposed or underexposed. In such a case, change the shutter speed until the aperture display stops blinking.

### (3) M: Manual Exposure and E-TTL Autoflash

In this mode, you set both the shutter speed and aperture. The E-TTL autoflash system controls the flash exposure based on the the aperture you set.

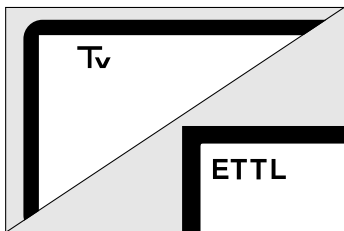

- 1 Set the camera's picture-taking mode to **M** and set the desired aperture and shutter speed anywhere from 30 sec. to the top sync speed. You can also use **buLb**.
- 2 Set the 550EX's flash mode to **ETTL**.
- 3 Focus the subject.
- 4 Check that the subject distance is within the flash range displayed on the 550EX's LCD panel.
- 5 Check that the ⚡ icon is displayed in the viewfinder, then take the picture.

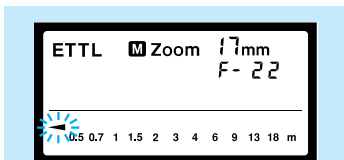

If the flash ranges below apply, the  icon will blink on the left end of the scale.

Zoom Setting	Flash Range
17-28mm	0.5 m / 1.6 ft or shorter
35mm and longer	0.7 m / 2.3 ft or shorter

# For Type-A Cameras

## Advanced Flash Photography

This section explains advanced flash operations possible with the Speedlite 550EX. It contains the following:

1. High-Speed Sync (FP Flash) (page 32)
2. FE Lock (page 34)
3. Flash Exposure Compensation (page 36)
4. FEB (Flash Exposure Bracketing) (page 38)
5. Bounce Flash (page 40)
6. Close-Distance Flash Photography (page 43)
7. Manual Flash Mode (page 44)
8. Stroboscopic Flash (page 46)
9. Second-Curtain Synchronization (page 49)
10. Modeling Flash (page 50)



- This section assumes that the 550EX is used with an EOS-3.
- Before proceeding, first turn on main switch on the EOS-3 and 550EX.
- Set the 550EX's wireless selector to OFF.
- For EOS-3 operations, refer to the EOS-3 Instructions.

# 1. High-Speed Sync (FP Flash)

When you set the synchronization mode to high-speed sync (FP flash), the camera can synchronize with the 550EX at all shutter speeds. When high-speed sync has been set,  is displayed in the viewfinder.

- High-speed sync can be used in the E-TTL and M flash modes.
- High-speed sync is especially effective for fill-flash portraits in daylight since you can:
  - (1) Obtain better background blur with a larger aperture.
  - (2) Create a catchlight in the subject's eyes.
  - (3) Soften shadows on the subject's face.

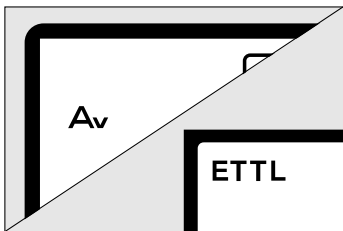

- 1 Select the camera's picture-taking mode and the Speedlite's flash mode.

- If you want to use a large aperture (smaller f-number), set the **Av** or **M** mode.

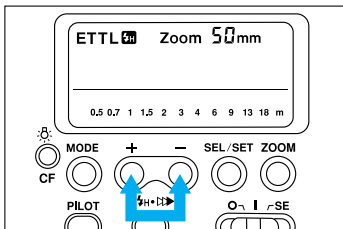

- 2 Press the **<+>** and **<->** buttons simultaneously to select  on the LCD panel.

- Each time you press the **<+>** and **<->** buttons simultaneously, the setting changes in the following loop.



- 3 Focus the subject.

- 4 Check that the subject is within the flash range displayed on the 550EX's LCD panel.





⚡ 2000 2.0 ●

- 5 Check that the ⚡ icon is displayed in the viewfinder, then take the picture.



With normal flash.



With high-speed sync.



- With high-speed sync, the Guide No. changes depending on the shutter speed (see page 121). The faster the shutter speed, the shorter the flash range will be. Check the current flash range on the 550EX's LCD panel.
- To cancel high-speed sync, press the <+> and <-> buttons simultaneously twice so that the ⚡ icon on the LCD panel turns off.
- When high-speed sync is used in the manual flash mode, the flash output ranges from 1/1 to 1/128.



If you use fill flash in the **Av** mode with high-speed sync, you can use a faster sync speed than the normal X-sync speed.

## 2. FE Lock

You can use FE (flash exposure) lock with Type-A cameras. This is the flash version of AE lock. With FE lock, you use spot metering to obtain the correct flash exposure reading for a specific part of the subject.

- FE lock works with E-TTL and high-speed sync (FP flash).

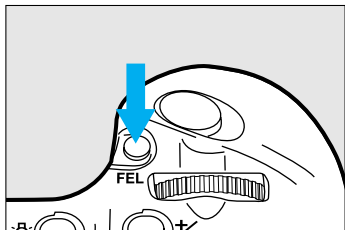

1 Select a picture-taking mode with the camera.

2 Focus the subject.

3 Aim the viewfinder's spot metering circle over the part of the subject to be metered. Then press the **<FEL>** button on the camera. FE lock remains effective for 16 sec.

- The 550EX fires a preflash to obtain an exposure reading. The reading is retained in memory.
- The focusing point linked to the FE lock lights in red.
- **FEL** is displayed in the viewfinder for 0.5 sec.
- You can also press the **<FEL>** button again to obtain an FE-lock reading for another part of the subject.
- To cancel FE lock, wait until 16 sec. elapse or press the **<MODE>**, **<AF>**, or **[Ⓜ]** button on the camera.



4 Recompose the picture as desired.

5 Check that the subject distance is within the flash range displayed on the 550EX's LCD panel.

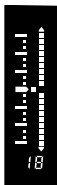
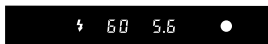

- 6 Check the flash exposure level in the viewfinder, then take the picture.



- If the subject is too far away to obtain a correct flash exposure,  will blink in the viewfinder. Either move closer to the subject or use a larger aperture (smaller f-number) and try again.
- FE lock cannot be used if the 550EX is set to the **M** (Manual) flash mode. With the EOS Elan II/50E/55 and EOS IX, the  icon blinks in the viewfinder to warn that FE lock cannot be used in the M flash mode.



- The FE lock's preflash fires at about 1/32 output.
- With Type-A cameras other than the EOS-1D, 1V, and 3, the AE lock button functions as an FE lock button when the 550EX is recharged and ready.
- If the subject is small, using FE lock might not make any difference.

### 3. Flash Exposure Compensation

Flash exposure compensation with the 550EX can be set up to  $\pm 3$  stops in 1/3-stop increments (or 1/2-stop increments with some cameras). You can also use flash exposure compensation in combination with normal exposure compensation (to control the background's exposure level) in a flash picture.

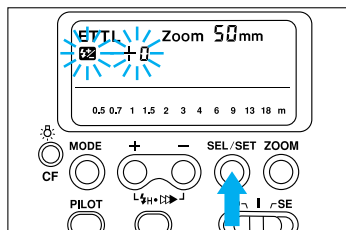

1 Press the **<SEL/SET>** button and select .

- Pressing the **<SEL/SET>** button changes the blinking setting in the following loop:

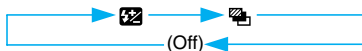

- The  icon and flash exposure compensation display blink.

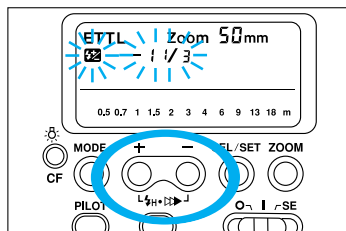

2 Press the **<+>** or **<->** button to set the desired flash exposure compensation amount.

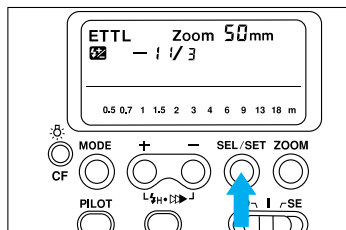

3 Press the **<SEL/SET>** button or press the shutter button halfway.

- The  icon and flash exposure compensation amount will stop blinking and remain displayed.

4 Focus the subject.

- When the shutter button is pressed halfway, the flash exposure compensation amount is displayed on the viewfinder's right and the  icon is displayed on the viewfinder bottom.



**5** Check that the subject is within the flash range displayed on the 550EX's LCD panel.



**6** Check that the  $\downarrow$  and  $\uparrow$  icons are displayed in the viewfinder, then take the picture.



- Flash exposure compensation set with the 550EX overrides any flash exposure compensation set with the camera.
- If the subject is small and the background is dark, flash exposure compensation may not give the desired result. In such a case, use the manual flash mode. See page 44.



### Effect on exposure of each type of compensation

	Effect
E-TTL flash exposure compensation	Changes the flash exposure of the main subject.
AE exposure compensation	Changes the exposure of the background.
Compensating the exposure by changing the film speed setting	Changes both the flash (main subject) exposure and the background exposure by the same amount.

## 4. FEB (Flash Exposure Bracketing)

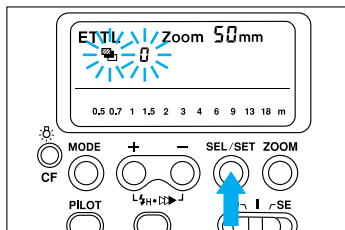

With FEB, you can obtain bracketed flash shots of the subject while the background exposure level remains the same. Three bracketed flash shots can be taken: Correct exposure, decreased exposure, and increased exposure. The three shots can be bracketed up to  $\pm 3$  stops in 1/3-stop increments (or 1/2-stop increments with some cameras). After all three bracketed flash shots are taken, FEB is canceled automatically.

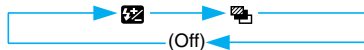

1 Press the **<SEL/SET>** button and select .

- Pressing the **<SEL/SET>** button changes the blinking setting in the following loop:



- The  icon and flash exposure bracketing display will blink.
- If the  icon appears, press the **<SEL/SET>** button again.

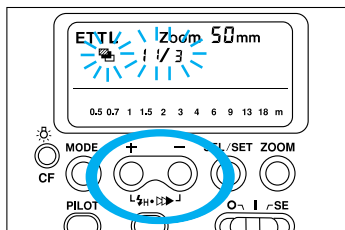

2 Press the **<+>** or **<->** button to set the flash exposure bracketing amount.

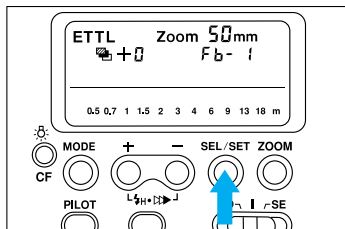

3 Press the **<SEL/SET>** button.

- The 550EX's LCD panel display will be similar to the figure on the left.

4 Focus the subject.

- When the shutter button is pressed halfway, the FEB setting is displayed on the viewfinder's right.

## FEB (Flash Exposure Bracketing)



**5** Check that the subject is within the flash range displayed on the 550EX's LCD panel.



**6** Check that the ⚡ icon is displayed in the viewfinder, then take the picture.

**7** Take the remaining two bracketed shots. (If necessary, repeat steps 4 to 6.)



Correct exposure.



Decreased exposure by 1 stop.



Increased exposure by 1 stop.



- The film advances according to the camera's current film advance mode.
- Before taking the picture, make sure the flash is ready by checking that the 550EX's pilot lamp is red or the ⚡ icon is displayed in the viewfinder. The □ (single-frame) film advance mode is recommended.
- In the , , or (continuous shooting) film advance mode, the next bracketed picture will not be taken if the flash is not ready. (You can still take a picture in the normal AE mode if you release your finger from the shutter button and press it completely.) When the flash is ready, you can continue taking the bracketed flash shots.
- With Type-A cameras other than the EOS-1D, 1V, and 3, bracketed flash shots cannot be taken while the flash is not ready. (You can still take pictures in the normal AE mode before the flash recharges completely.) When the flash is ready, you can continue taking the bracketed flash shots.



- FE lock and FEB can be used in combination.
- If FEB has been set and flash exposure compensation is set with the 550EX, the FEB amount will shift in accordance with the flash exposure compensation amount.

**CF**

Custom Function CF-1 can prevent the FEB setting from canceling automatically after the three bracketed flash shots are taken. See page 113.

**CF**

Custom Function CF-2 can change the sequence of the bracketed flash shots. See page 113.

## 5. Bounce Flash

With direct, frontal flash, harsh shadows are usually created in the background behind the subject. This can be avoided by bouncing the flash off a nearby wall or ceiling. Bounce flash also gives softer lighting effects.

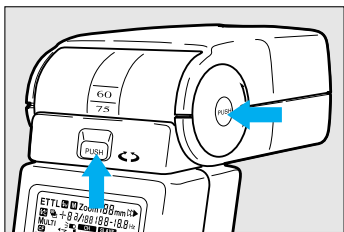

- 1 To turn the flash head, press the **<PUSH>** button. To tilt the flash head, press the **<TILT>** button. Turn and/or tilt the flash head and point it at a wall, ceiling, or other reflective surface.

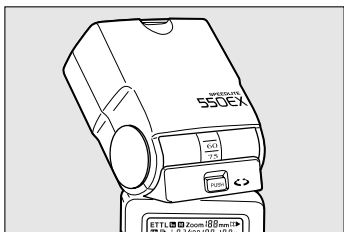

The flash head can be pointed in the directions and angles listed below.

Direction	Maximum Angle	Click Stops
Up	90°	0°, 60°, 75°, 90°
Down*	7°	0°, 7°
Left	180°	0°, 60°, 75°, 90°, 120°, 150°, 180°
Right	90°	0°, 60°, 75°, 90°

\* See page 43.

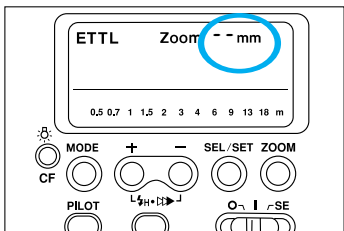

- 2 When the flash head is turned or tilted, **-- mm** is displayed on the 550EX's LCD panel.

- When the flash head's zoom setting is automatic and the flash head is turned or tilted, the zoom setting is set automatically to 50mm. The zoom setting can also be set manually for bounce flash.
- If a manual zoom setting **M** has been set, the zoom setting display does not change when the flash head is turned or tilted.

- 3 Focus the subject.



⚡ 2000 2.0 ●

**4** Check that the ⚡ icon is displayed in the viewfinder, then take the picture.

- If the flash exposure confirmation lamp does not light after you take the picture, use a larger aperture (smaller f-number) and try again.



With bounce flash.



Without bounce flash.



Bounce the flash on a plain, white, reflective surface. If a colored surface is used, the picture may have a color cast.

## Bounce Flash

### ● Creating a Catchlight

A catchlight is a reflection of the flash in the subject's eyes. A catchlight in the eyes makes the subject look more lively. For portraits, you can easily create a catchlight with the 550EX.

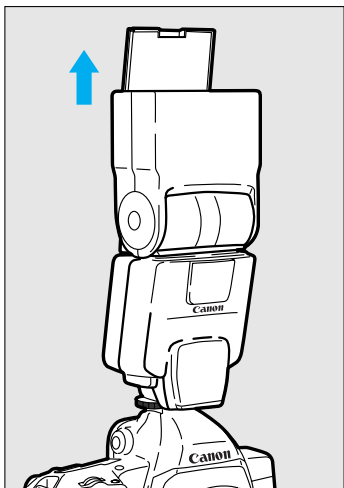

Tilt the flash head upward all the way by 90°. Extend the built-in wide panel until it clicks in place as shown in the figure. To take a picture, follow the same procedure in "5. Bounce Flash."



- Turning the flash head left or right will not produce a catchlight. Tilt the flash head up by 90° and use it in that position.
- The subject should not be farther than 1.5 meters / 4.9 ft from the camera.

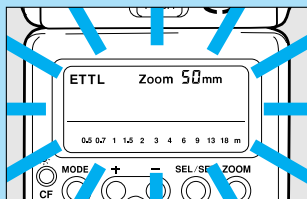

If the wide panel is extended while the flash head is at the normal or 7° downward tilt position, the 550EX's LCD panel display will blink as a warning. Tilt the flash head upward by 90°.

## 6. Close-Distance Flash Photography

The flash head can be tilted downward by 7°. This position enables the flash to better illuminate the lower part of a subject that is close to the camera.

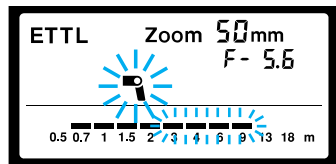

Press the  $\langle \text{MENU} \rangle$  button and tilt the flash head downward until it stops. The  icon will blink on the LCD panel.

- This flash head position is effective only for subjects 0.5 meter / 1.6 ft to 2 meters / 6.6 ft from the camera.
- The flash range will be displayed as shown in the left figure.

## 7. Manual Flash Mode

In the manual flash mode, you can set the flash output from 1/1 (full) to 1/128 power in full-stop increments.

- To prevent overheating and deterioration of the flash head, observe the following limits for continuous shooting with flash:

- (1) At 1/1 or 1/2 output: Max. 15 continuous flash shots.
- (2) At 1/4 or 1/8 output: Max. 20 continuous flash shots.
- (3) At 1/16 or 1/32 output: Max. 40 continuous flash shots.

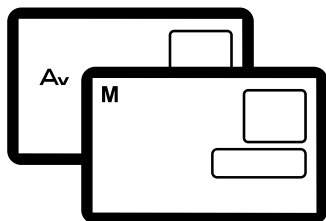

- 1 Set the camera's picture-taking mode to **Av** or **M**.

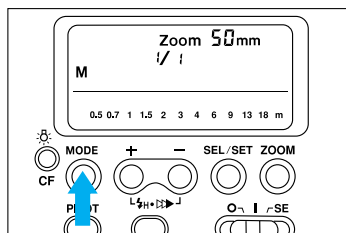

- 2 Press the 550EX's **<MODE>** button and select **M**.

- Pressing the **<MODE>** button changes the flash mode in the following loop:

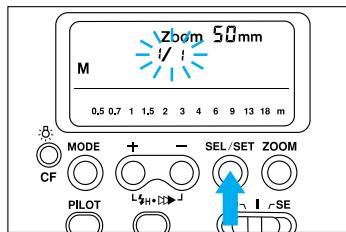

- 3 Press the **<SEL/SET>** button.

- The manual flash output display blinks.

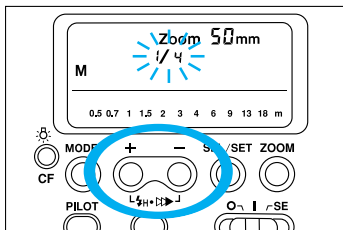

**4** Press the **<+>** or **<->** button to set the desired flash output.

- Each time the button is pressed, the flash output changes by one stop.

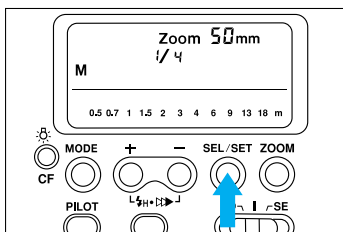

**5** Press the **<SEL/SET>** button again. The manual flash output display will stop blinking and remain displayed.

**6** Focus the subject.

- When you press the shutter button halfway, focus will be achieved and the aperture and flash range (bar segment) will be displayed on the LCD panel.



**7** Check the focusing distance on the lens.

**8** Check the flash range on the LCD panel. If the flash range does not match the focusing distance, change the aperture until it does match.

- You can also change the flash output until the flash range matches the focusing distance.



**9** Check that the **⚡** icon is displayed in the viewfinder, then take the picture.



- If there is a large difference between the flash range and focusing distance, change the flash output or use a larger aperture until they match.
- To obtain a more precise flash exposure, use a hand-held flash meter.

## 8. Stroboscopic Flash

With stroboscopic flash, a rapid series of flashes is fired. It can be used to record multiple images of a moving subject in a single photograph for later study.

You can set the firing frequency (the number of flashes per sec. expressed as Hz) from 1 Hz to 199 Hz. The firing frequency can be set in 1-Hz increments from 1 Hz to 20 Hz, in 5-Hz increments from 25 Hz to 50 Hz, and in 10-Hz increments from 60 Hz to 199 Hz.

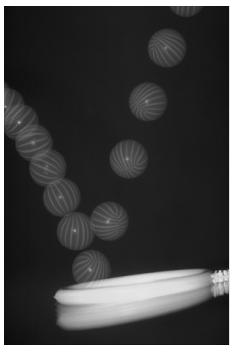

Up to 100 flashes can be fired continuously. This maximum varies depending on the flash output and firing frequency. See “Maximum Continuous Flashes” on page 122.

### ● Setting the Firing Frequency, Flash Count, and Flash Output

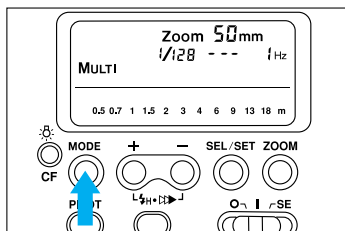

1 Press the **<MODE>** button and select **MULTI**.

- Pressing the **<MODE>** button changes the flash mode in the following loop:



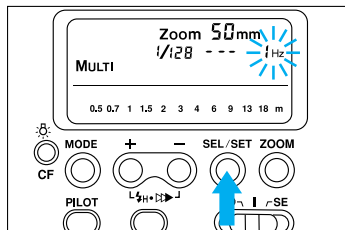

- 2** Press the **<SEL/SET>** button to select the firing frequency, flash count, or flash output display. When selected, the respective item blinks on the LCD panel to indicate that it can be altered. Pressing the **<SEL/SET>** button changes the blinking item in the following loop:

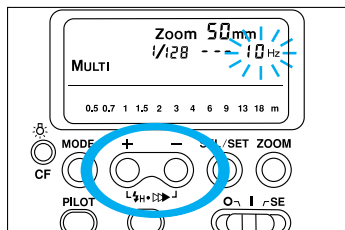
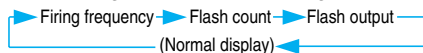

- 3** Press the **<+>** or **<->** button to set the desired value for the blinking item.

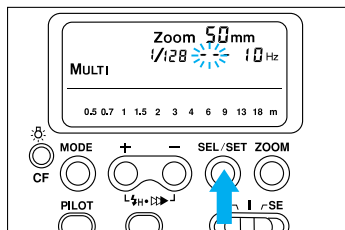

- 4** Press the **<SEL/SET>** button again to register the value. The item will then stop blinking and remain displayed. The next item will then start blinking. Repeat steps 3 and 4 to set the next item.

- After you set the flash output and press the **<SEL/SET>** button, the firing frequency, flash count, and flash output are displayed.

## ● Shooting With Stroboscopic Flash

To shoot with stroboscopic flash, you must set a shutter speed that gives the 550EX enough time to fire according to the firing frequency and flash count you have set.

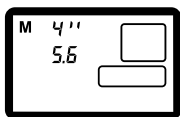

- 1** Set the camera's picture-taking mode to **M** and set the desired aperture.

## Stroboscopic Flash

- 2 Use the following formula to calculate the required shutter speed.

$$\begin{aligned} & \text{Flash count} \div \text{Firing frequency} \\ & = \text{Shutter speed} \end{aligned}$$

**Example:** If the flash count is 10 and the firing frequency is 5 Hz, the shutter speed will have to be at least 2 sec.

$$10 \div 5 = 2$$

- If the flash count display is --, the flash will keep firing until the shutter speed ends or until the maximum number of continuous flashes (as indicated in the table on page 122) is fired.

- 3 Focus the subject.

- To set the exposure settings, see "Manual Flash Mode" on page 44.



- 4 Check that the ⚡ icon is displayed in the viewfinder, then take the picture.



To prevent overheating and deterioration of the flash head, do not use stroboscopic flash for more than 10 frames in rapid succession. After 10 frames, allow the 550EX to cool for at least 10 minutes.



- Stroboscopic flash is most effective with highly reflective subjects in front of a dark background.
- Using a tripod and Remote Switch are recommended.
- Using an external power source is recommended for stroboscopic flash.





- Stroboscopic flash cannot be used at a flash output of 1/1 or 1/2.
- **buLb** can also be used with stroboscopic flash.



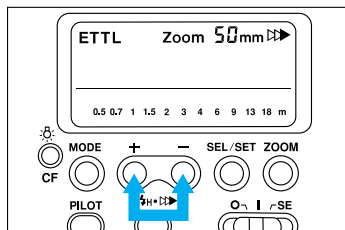

## 9. Second-Curtain Synchronization

Normally, the flash fires in synchronization with the first shutter curtain when the shutter is fully open. With second-curtain synchronization, the flash fires immediately before the second shutter curtain closes at the end of the exposure. With second-curtain synchronization and a slow shutter speed, you can create a trailing blur (illuminated by ambient light) that trails a moving subject (illuminated by the flash) to give a natural-looking illusion of motion.

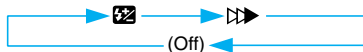

- 1 Set the desired picture-taking mode with the camera.
- 2 Press the <+> and <-> buttons simultaneously to select  on the LCD panel.
  - Each time you press the <+> and <-> buttons simultaneously, the synchronization mode changes in the following loop:



- 3 Check that the  icon is displayed in the viewfinder, then take the picture.





With second-curtain synchronization.



With first-curtain synchronization.



- Second-curtain synchronization is easier with **buLb**.
- With the EOS 500N/REBEL G, 3000N/66/REBEL XSN, TTL autoflash is used with second-curtain synchronization.
- Second-curtain synchronization does not work with the camera's  picture-taking mode and Programmed Image Control modes.
- To cancel second-curtain synchronization, press the <+> and <-> buttons simultaneously to turn off the  icon on the LCD panel.

## 10. Modeling Flash

When the 550EX is used with the EOS-1D, 1V, 3, D60, D30, ELAN 7/7E, and 30/33, a modeling flash can be fired so you can check the lighting and shadow effects before you take the picture.

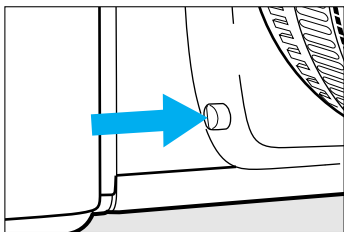

Set the desired flash photography settings with the camera and 550EX.

Press the camera's depth-of-field preview button.

- The aperture will stop down.
- The 550EX will fire a series of flashes at 70 Hz for 1 sec.

**CF**

Custom Function CF-6 can disable the modeling flash and prevent it from firing. See page 113.



To prevent overheating and deterioration of the flash head, do not fire the modeling flash more than 10 times in succession. After 10 times, allow the 550EX to cool for at least 10 minutes.

# For Type-A Cameras

## Wireless Flash Photography

This section covers wireless flash photography with the 550EX. It explains the 550EX's built-in master and slave flash features.

### 550EX Wireless Flash Features

- A wireless flash system with multiple Speedlite 550EXs can be used as easily as a single, on-camera Speedlite 550EX.
- Up to three 550EXs or three groups of 550EXs can be set as slave units for automatic control.
- 550EXs set as slave units can be positioned to obtain the desired lighting effects. All of their settings are controlled by the master unit and camera.

[1] Wireless System Setup and Testing (page 52)

[2] Wireless E-TTL Autoflash (page 60)

[3] Wireless Manual Flash (page 71)

[4] Wireless Stroboscopic Flash (page 73)

[5] Manual or Stroboscopic Flash With a Slave Unit (page 74)



- This section assumes that the Speedlite 550EX is used with the EOS-3.
- Before proceeding, first turn on the main switch on the EOS-3 and 550EX.
- In these Instructions, a Speedlite 550EX whose wireless selector has been set to **MASTER** is called the “master unit” and a 550EX whose wireless selector has been set to **SLAVE** is called a “slave unit.”
- For EOS-3 operations, refer to the EOS-3 Instructions.
- With the EOS ELAN II/ELAN IIE, 50/50E, 300/REBEL 2000, 500N/REBEL G, 3000N/66/REBEL XSN, IX, and IX 7/IX Lite, only one slave group can be used for wireless E-TTL autoflash control.
- Quick flash cannot be used with wireless flash photography.

## [1] Wireless System Setup and Testing

The wireless flash system can be setup in one of two ways: ① With a 550EX set as the master unit and one or more 550EXs set as slave units. ② With Speedlite Transmitter ST-E2 (sold separately) used as the master unit and one or more 550EXs set as slave units.

This section describes the procedure for the former. For the latter, refer to the Instructions for Speedlite Transmitter ST-E2.

### 1. Setting the 550EX as the Master Unit



Attach the 550EX to the camera and set the wireless selector to **MASTER**. This 550EX will then be the “master unit.” The master unit’s wireless signal is transmitted to the slave unit(s) at almost the same time as the preflash.



The master unit’s flash head zoom setting is set automatically to **M 24mm**. This gives the wireless signal the maximum coverage of 80°. You can also press the **Zoom** button to change the zoom setting manually. However, this will narrow the wireless signal’s coverage.

## 2. Setting the 550EX as a Slave Unit

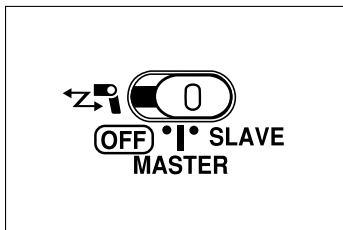

Set the wireless selector to **SLAVE** on the 550EX to be used as a slave unit. A 550EX set in this way is called a “slave unit.”

- The slave unit's flash head zoom setting is set automatically to **M 24mm**.



You can change the slave unit's flash head zoom setting manually with the **ZOOM** button.

### 3. Setting the Master/Slave Channel

To prevent your master unit from firing another photographer's slave units, four channels are provided to differentiate your slave units from unrelated ones. The master unit and slave unit(s) in the same wireless flash system must be set to the same channel No.

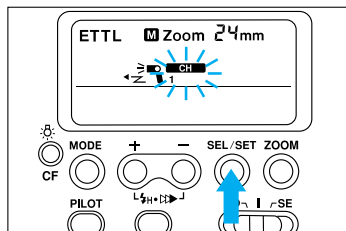

- 1 To set the master unit's channel No., press the **<SEL/SET>** button and select **CH**.

- Pressing the **<SEL/SET>** button changes the selection in the following loop:

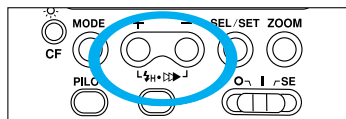
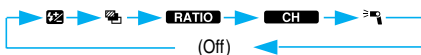

- 2 Press the **<+>** or **<->** button to set the channel No. (1, 2, 3, or 4).

- 3 Press the **<SEL/SET>** button.

- The **CH** icon and channel No. will be displayed.

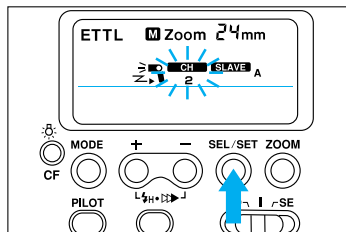

- 4 To set the slave unit's channel No., press the **<SEL/SET>** button and select **CH**.

- Pressing the **<SEL/SET>** button changes the selection in the following loop:

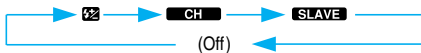

## Setting the Master/Slave Channel

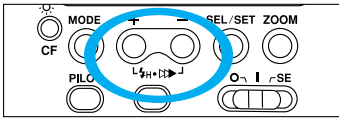

- 5 Press the <+> or <-> button to set the same channel No. (1, 2, 3, or 4) as the master unit's.

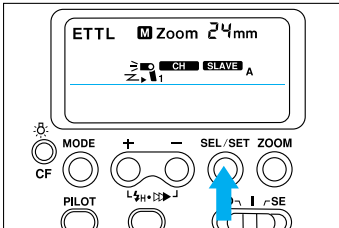

- 6 Press the <SEL/SET> button.
- The **CH** icon and channel No. will be displayed.



If the master unit and slave unit(s) are not set to the same channel No., the master unit will be unable to trigger the slave unit's flash. Make sure the channel No. is the same.

## 4. Setting the Slave ID

With multiple slave units, a slave ID can be assigned to distinguish a slave unit as being the main flash or fill flash. A flash ratio can thereby be set. Three slave IDs are available: A, B, and C.

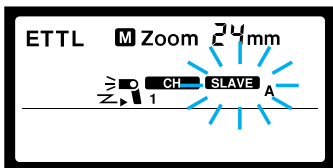

**1** To set a slave unit's slave ID, press the **<SEL/SET>** button and select **SLAVE**.

- Pressing the **<SEL/SET>** button changes the selection in the following loop:



**2** Press the **<+>** or **<->** button to set the slave ID (A, B, or C).

**3** Press the **<SEL/SET>** button.

- The **SLAVE** icon and slave ID will be displayed.







If you want all the slave units to fire at the same flash output, you need not assign a slave ID.



## 5. Master Flash ON/OFF

The master unit's flash firing can be enabled (ON) or disabled (OFF).

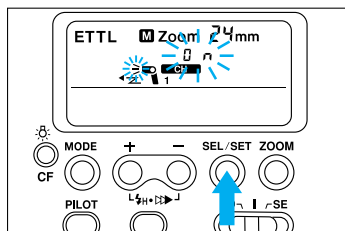

-  (  ON ) : This setting enables the master unit to fire a flash.
  - This setting is called "Master flash ON."
  - This setting automatically sets the master unit's slave ID to A.
-  (  FF ) : This setting (Master flash OFF) prevents the master unit from firing a flash. It can still transmit wireless signals to trigger the slave units.



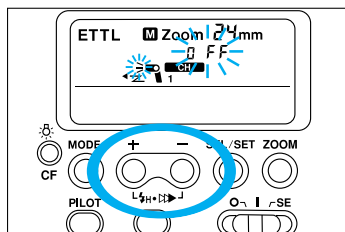

- 1 Press the **<SEL/SET>** button and select .

- Pressing the **<SEL/SET>** button changes the selection in the following loop:



- 2 Press the **<+>** or **<->** button to set either  or  FF.

- 3 Press the **<SEL/SET>** button.

-  or  will appear.
- If master flash OFF is set,  will blink.



Even if master flash OFF is set, the master unit still transmits the wireless signal to fire the slave units.

## 6. Wireless Flash Range

After the master and slave units have been set, position them within the wireless flash range shown below.

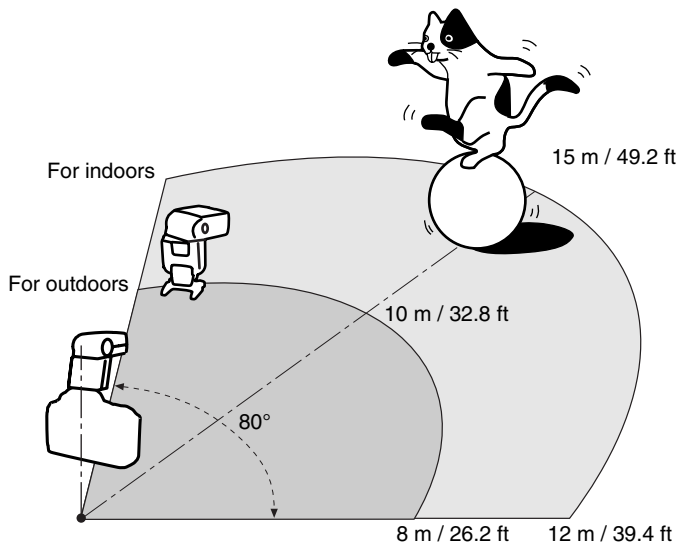

- Use the mini stand (provided) for the slave unit(s). The mini stand also has a tripod socket.
- Use the bounce feature to turn the body of the slave unit so that the sensor is exposed to the master unit.
- For an indoor setup, the positioning can be less precise since the wireless signals can bounce off the walls.
- After positioning the master and slave unit(s), fire a test flash to make sure the wireless flash system works.
- Do not place any objects between the master unit and slave unit(s) which may obstruct the wireless transmission.

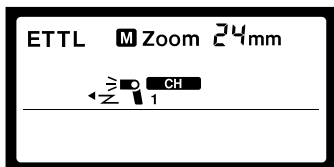

- 1 Set the master unit's flash mode to E TTL.
- 2 Set the camera as desired for flash photography.

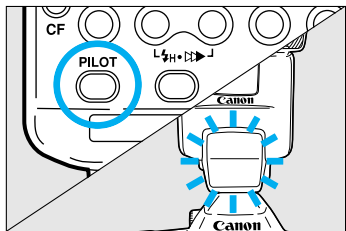

### 3 Check that the master unit's pilot lamp is lit and that the slave unit(s) are recharged and ready.

- When a slave unit is ready, its AF-assist beam blinks once per second.

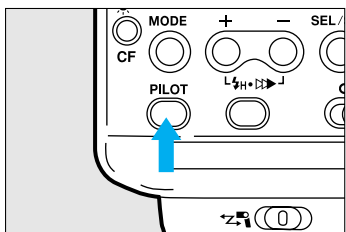

### 4 Press the master unit's pilot lamp (test firing button) to fire a test flash.

- When the wireless transmission works, the slave units fire at 1/64 output in the following slave ID order: A, B, and C.
- If a slave unit does not fire, place it closer to the master unit or angle the sensor more toward the master unit and try again.



- In a wireless flash system, the flash mode (E-TTL autofocus, high-speed sync, manual flash, stroboscopic flash), flash exposure compensation, flash exposure bracketing, and other settings are all set with the master unit. The master unit transmits all these settings to the slave units by wireless signals. Controlling slave unit(s) is the same as controlling one on-camera Speedlite.
- A modeling flash can be fired to check the lighting effects (lighting balance, shadows, etc.) before you take the picture. See page 50.
- Make sure the slave units are within the effective range of the master unit.
- After the picture is taken, the slave unit's operation result is displayed on the LCD panel.
- With the slave unit's main switch set to SE (Save Energy), the slave unit turns off automatically if it is left unused for over 60 minutes\*. While the slave unit is off due to this SE mode, SE is displayed on the LCD panel. Within 1 hour\*\* after the slave unit turns off in the SE mode, the slave unit can be turned on again by pressing the master unit's test firing button.
- If the manual flash mode has been set and you press the master unit's pilot lamp, all the slave units will fire a test flash simultaneously at the manually-set flash output.
- After pressing the shutter button halfway, test firing cannot be executed during the first 6 sec.

**CF**

\* Custom Function CF-4 can change this to 10 minutes. See page 113.

\*\* Custom Function CF-5 can change this to 8 hours. See page 113.

## [2] Wireless E-TTL Autoflash

Wireless E-TTL autoflash with multiple Speedlite 550EXs can be used in one of two ways:

- (1) **RATIO OFF** : All slave units fire at the same flash output.
  - (2) **RATIO ON** : Slave units with different slave IDs (A, B, or C) can be fired at different flash outputs to produce a flash ratio.
- A flash ratio can be set only with the EOS-1D, 1V, 3, D60, D30, ELAN 7/7E, and 30/33.
  - With the EOS ELAN II/ELAN IIE, 50/50E, 300/REBEL 2000, 500N/REBEL G, 3000N/66/REBEL XSN, IX, and IX 7/IX Lite, a flash ratio cannot be set with the master unit.

### 1. Wireless E-TTL Autoflash With Flash Ratio OFF

If no flash ratio is desired, the slave ID does not matter. It can be A, B, or C. All the slave units will fire at the same flash output. The E-TTL autoflash system controls the total flash amount automatically to obtain a correct flash exposure.

#### ● Master Flash ON + Slave Unit(s)

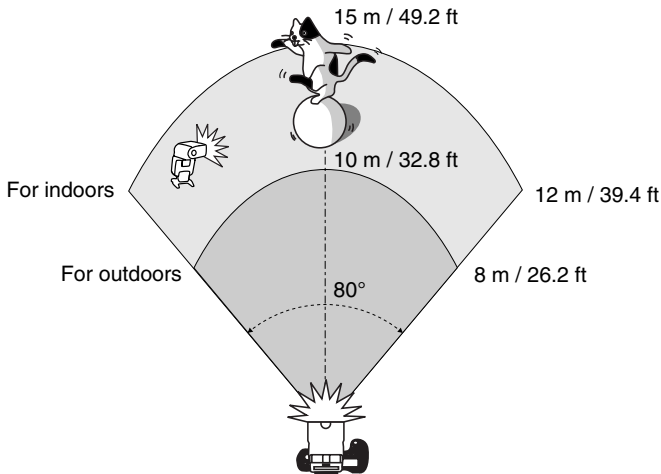

## Wireless E-TTL Autoflash With Flash Ratio OFF

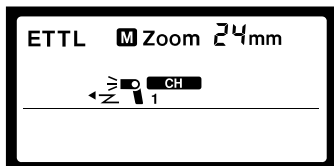

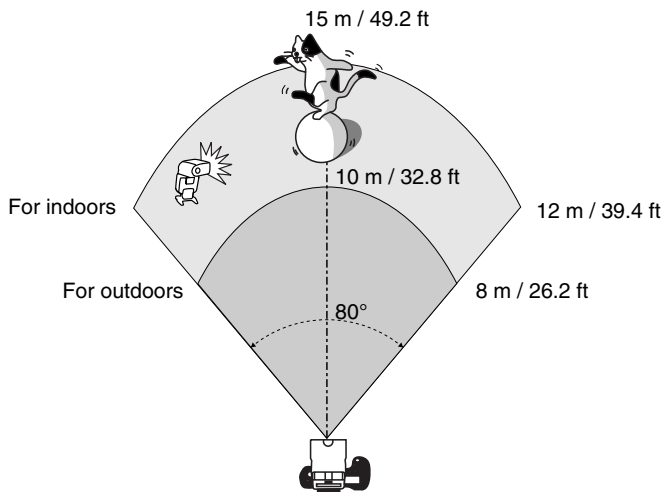

- 1 Check for the following icons on the master unit's LCD panel:
  - **ETTL** displayed
  - **RATIO** not displayed
  -  displayed
- 2 Make sure the master unit's pilot lamp is lit and the slave units are ready.
- 3 Press the pilot lamp to test the wireless transmission.
- 4 Focus the subject and take the picture.

### ● Master Flash OFF + Slave Unit(s)

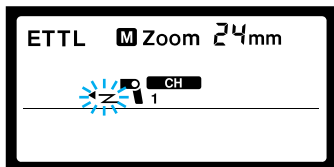

## Wireless E-TTL Autoflash With Flash Ratio OFF



- 1 Check for the following icons on the master unit's LCD panel:
  - E-TTL displayed
  - **RATIO** not displayed
  -  displayed
- 2 Make sure the master unit's pilot lamp is lit and the slave units are ready.
- 3 Press the pilot lamp to test the wireless transmission.
- 4 Focus the subject and take the picture.



- The master unit can also be set for bounce flash.
- With master flash OFF, you can use one slave unit as a wireless off-camera Speedlite.
- Any number of slave units can be used.
- The flash ratio can also be changed by changing the distance of the slave units to the subject. With the EOS-1D, 1V, 3, D60, D30, ELAN 7/7E, and 30/33, you can use the modeling flash to check the lighting effects.

## 2. Wireless E-TTL Autoflash With Flash Ratio ON

As shown in the figure below, the wireless E-TTL autoflash system described as an example consists of a master unit set to master flash OFF and two slave units.

- The slave ID of the slave unit on the camera's left is A.
- The slave ID of the slave unit on the camera's right is B.
- Master flash OFF is set for the master unit.
- The camera (attached with the master unit) and two slave units are properly positioned for the subject.

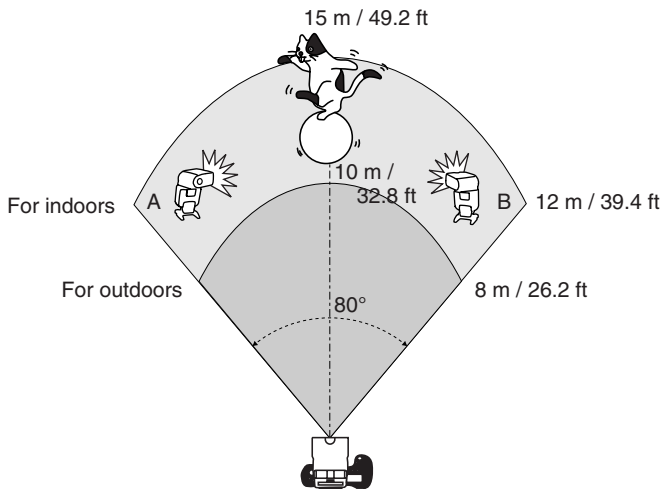

### ● Setting the Flash Ratio for Two Slave Units: A and B

With slave unit A being the main flash and slave unit B being the fill flash, the flash ratio (A:B) between these two slave units can be set from 8:1 to 1:1 or from 1:1 to 1:8. (Thirteen 1/2-stop increments.) In terms of stops, the flash ratio can be adjusted from 3:1 to 1:1 or from 1:1 to 1:3. The E-TTL autoflash system then controls the total flash amount according to the flash ratio to obtain a correct exposure.

## Wireless E-TTL Autoflash With Flash Ratio ON

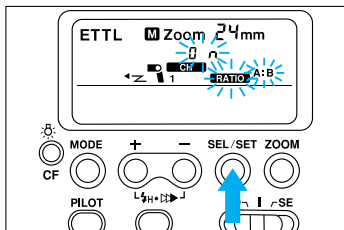

- 1 On the master unit, press the <SEL/SET> button and select **RATIO**.

- Pressing the <SEL/SET> button changes the selection in the following loop:

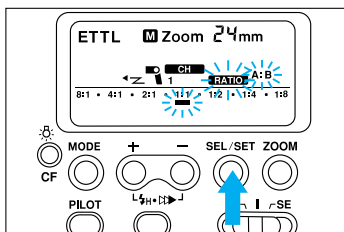

- 2 Press the <-> button to select **RATIO** ON A:B.

- RATIO** ON A:B will blink.

- 3 Press the <SEL/SET> button again.

- RATIO** A:B and **—** (flash ratio bar) will blink.
- In the left figure, the flash ratio bar indicates a flash ratio of 1:1.

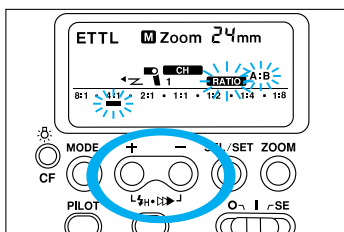

- 4 Press the <+> or <-> button to set the A:B flash ratio.

- Press the <+> button to move the flash ratio bar to the left, or press the <-> button to move it to the right on the flash ratio scale.



## Wireless E-TTL Autoflash With Flash Ratio ON

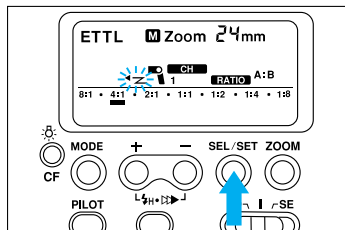



5 Press the **< SEL/SET >** button to register the flash ratio.

- The flash ratio bar stops blinking and remains displayed.
- To indicate that a flash ratio has been set, **RATIO** A:B will remain displayed on the master unit's LCD panel.

6 Follow the basic procedure for wireless E-TTL autoflash picture-taking on page 60 and take the picture.



- During the setting procedure, A:B and  blink for 8 sec. and then remain displayed. To make them blink again (so you can alter the flash ratio), press the **< SEL/SET >** button again.
- The flash ratios corresponding to the  positions on the flash ratio scale are shown below.

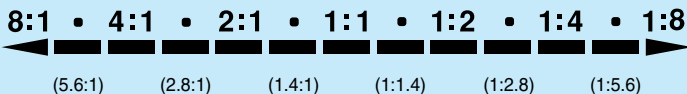

- Flash ratios of A:C and B:C cannot be set.



After you set the flash ratio and the flash ratio bar is displayed, you can still change the A:B flash ratio with the **< + >** and **< - >** buttons.

### ● Setting the Flash Ratio for Three Slave Units: A, B and C

With three wireless slave units, slave unit A is the main flash, slave unit B is the fill flash, and slave unit C is a supplemental flash. Thus, slave units A and B serve to illuminate the subject for a proper exposure while slave unit C illuminates the background to eliminate shadows. Even with three slave units, the E-TTL autoflash system controls the flash to obtain a correct exposure. In addition to setting the A:B flash ratio, a flash ratio of (A:B):C can also be set. This is done by adjusting slave unit C's flash exposure compensation amount.

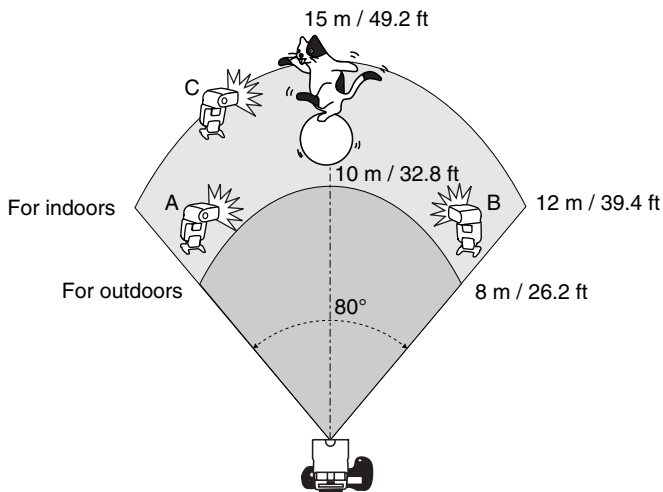

## Wireless E-TTL Autoflash With Flash Ratio ON

The following wireless E-TTL autoflash procedure is for a master unit with three slave units. This procedure sets the A:B flash ratio and the flash exposure compensation amount for slave unit C.

- The flash ratio range for A:B is the same as when only two slave units are used.
- Flash exposure compensation with slave unit C can be set up to  $\pm 3$  stops in 1/3 or 1/2-stop increments.
- The slave ID of the slave unit on the camera's left is A.
- The slave ID of the slave unit on the camera's right is B.
- The slave ID of the slave unit illuminating the background is C.
- Master flash OFF is set for the master unit.
- The camera (attached with the master unit) and three slave units are properly positioned for the subject.

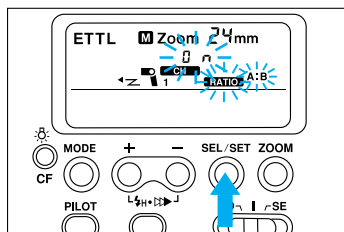

- 1 On the master unit, press the **<SEL/SET>** button and select **RATIO**.

- Pressing the **<SEL/SET>** button changes the selection in the following loop:



- 2 Press the **<->** button to select **RATIO ON A:B**.

- **RATIO ON A:B** will blink.

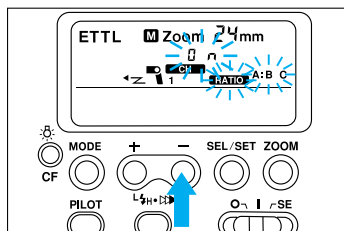

- 3 Press the **<SEL/SET>** button again to select **RATIO ON A:B C**.

- **RATIO A:B C** will blink.

## Wireless E-TTL Autoflash With Flash Ratio ON

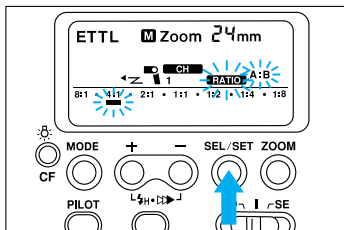

- 4 Press the **<SEL/SET>** button.
- **RATIO A:B** and **—** (flash ratio bar) will blink.

- 5 Press the **<+>** or **<->** button to set the A:B flash ratio.

- Press the **<+>** button to move the flash ratio bar to the left, or press the **<->** button to move it to the right on the flash ratio scale.

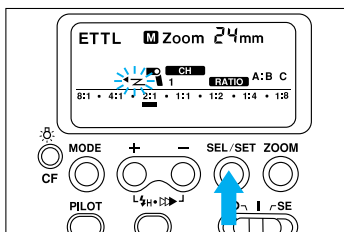

- 6 Press the **<SEL/SET>** button.
- The flash ratio bar and **RATIO A:B:C** remain displayed.

- 7 Press the **<SEL/SET>** button again.

- The **—** for **A:B** will blink.
- To change the flash ratio, repeat steps 4 to 6.

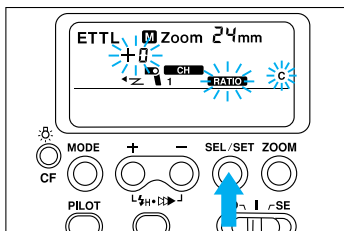

- 8 Press the **<SEL/SET>** button again.

- **RATIO C** and the flash exposure compensation display will blink.

- 9 Press the **<+>** or **<->** button to set the flash exposure compensation amount for **C**.

## Wireless E-TTL Autoflash With Flash Ratio ON

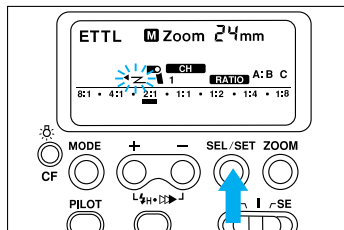

10 Press the **< SEL/SET >** button to register the setting.

- The flash ratio bar and **RATIO A:B:C** remain displayed.
- To change the flash exposure compensation amount, repeat steps 8 to 10.

11 Follow the basic procedure for wireless E-TTL autoflash on page 60 and take the picture.



- Even if you have slave units A, B, and C, if only **RATIO A:B** is selected, slave unit C will not fire.
- If slave unit C is used to illuminate the subject directly, overexposure may result.

## ● Slave Groups

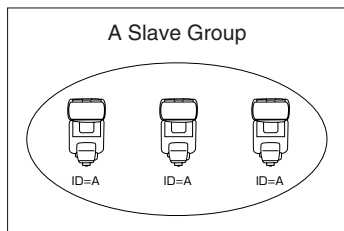

Multiple slave units having the same slave ID will be recognized and controlled as one slave group. The group will be treated as one slave unit.

- In the left figure, the slave ID is A for all three slave units. They will be controlled as slave unit A even as a group.

## Wireless E-TTL Autoflash With Flash Ratio ON

### ● Wireless High-Speed Sync (FP Flash)

After setting up the wireless flash system with one or more slave units, you can enable wireless high-speed sync by setting  on the master unit.

- You need not touch any controls on the slave units.
- The procedure for setting wireless high-speed sync is the same as for normal high-speed sync. See page 32.

### ● Wireless FE Lock

After setting up the wireless flash system with one or more slave units, you can enable wireless FE lock by pressing the camera's <FEL> button.

- You need not touch any controls on the slave units.
- The procedure for setting wireless FE lock is the same as for normal FE lock. See page 34.



If there are multiple slave units and one of them cannot provide the proper exposure, the  icon in the viewfinder will blink as a warning. Either use a larger aperture or place the slave unit closer to the subject and try FE lock again.

### ● Wireless Flash Exposure Compensation

After setting up the wireless flash system with one or more slave units, you can enable wireless flash exposure compensation by setting the flash exposure compensation amount with the master unit.

- You need not touch any controls on the slave units.
- The procedure for setting wireless flash exposure compensation is the same as for normal flash exposure compensation. See page 36.



You can also set flash exposure compensation individually for each slave unit. See page 36.

### ● Wireless Flash Exposure Bracketing (FEB)

After setting up the wireless flash system with one or more slave units, you can enable wireless FEB by setting the flash exposure bracketing amount with the master unit.

- You need not touch any controls on the slave units.
- The procedure for setting wireless FEB is the same as for normal FEB. See page 38.

## [3] Wireless Manual Flash

After setting up the wireless flash system, you can manually set the slave unit's flash output with the master unit. The flash output can be uniform or varied among the slave units. To determine the proper flash exposure, use a hand-held flash meter.

### 1. Wireless Manual Flash With Uniform Flash Output

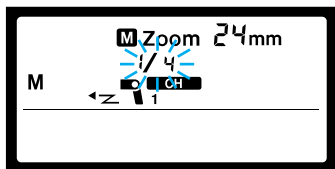
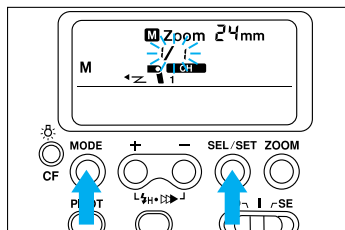

**1** On the master unit, press the **<MODE>** button and select **M**.

**2** Press the **<SEL/SET>** button and select the flash output display.

- Pressing the **<SEL/SET>** button changes the selection in the following loop:

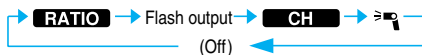

**3** Press the **<+>** or **<->** button to set the desired flash output.

**4** Press the **<SEL/SET>** button.

- The flash output will be displayed.



- When you take the picture, all the slave units will fire at the flash output you have set with the master unit.
- If master flash ON is set, the master unit will also fire at the same flash output.
- If a slave group is used, all the slave units in the group will fire at the flash output you have set with the master unit.

## 2. Wireless Manual Flash With Varied Flash Output

You can set a different flash output for each slave unit (A, B, and C) as follows.

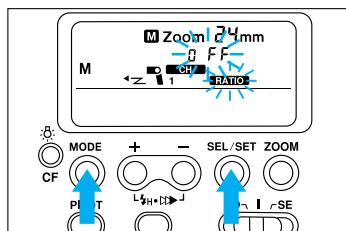

1 On the master unit, press the <MODE> button and select **M**.

2 Press the <SEL/SET> button and select **RATIO**.

- Pressing the <SEL/SET> button changes the selection in the following loop:

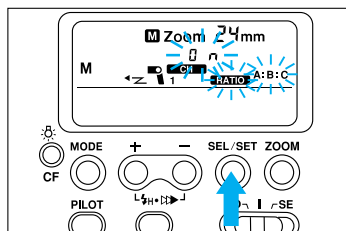
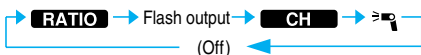

3 Press the <-> button to select **RATIO ON A:B** or **A:B:C**.

- RATIO ON A:B** or **A:B:C** will blink.

4 Press the <SEL/SET> button.

- A** and the flash output display will blink.

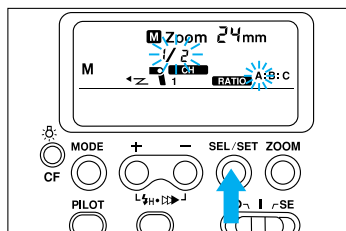

5 Press the <+> or <-> button to set the flash output for **A**.

6 Press the <SEL/SET> button.

- B** and the flash output display will blink.



## Wireless Manual Flash With Varied Flash Output

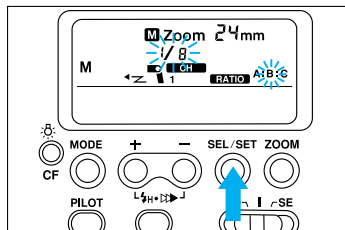

7 Press the **< + >** or **< - >** button to set the flash output for **B**.

8 Press the **< SEL/SET >** button.  
• **C** and the flash output display will blink.

9 Press the **< + >** or **< - >** button to set the flash output for **C**.

10 Press the **< SEL/SET >** button to register the settings.

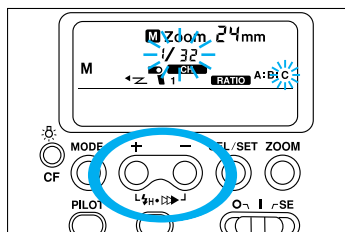

- If there are only two slave units (A and B), steps 9 and 10 may be omitted.
- After you complete the settings, you can check the respective flash output for slave units A, B, and C by pressing the **< + >** or **< - >** button.
- Press the master unit's pilot lamp to test fire the slave units.

## [4] Wireless Stroboscopic Flash

After setting up the wireless flash system, you can set stroboscopic flash with the master unit for wireless stroboscopic flash.

- The firing frequency and flash count will be the same for all slave units. They can be set by following the procedure on page 46.
- Set the flash output of the slave units in the same way as for wireless manual flash. See page 71.
- To determine the proper exposure, take test shots and experiment.

## [5] Manual or Stroboscopic Flash With a Slave Unit

Manual flash or stroboscopic flash can be set manually with a slave unit. The setting is independent from the master unit. The master unit just triggers the slave unit which fires according to its own independent (manual or stroboscopic flash) setting. This feature can be used in the following situations:

- (1) As with studio flash, you can set the slave unit's flash output yourself for wireless manual flash photography.
- (2) For wireless manual flash photography with Wireless Transmitter ST-E.

### 1. Setting Manual Flash With a Slave Unit

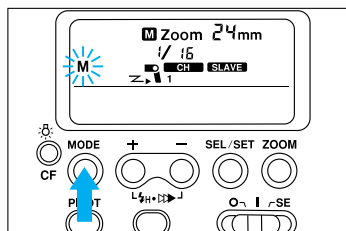

On a slave unit with the wireless selector to <SLAVE>, press the <MODE> button for at least 2 sec.

**M** will start blinking. It will continue to blink while the slave unit's independent setting is in effect.

To set the flash output, see page 44.



To determine the proper flash exposure, use a hand-held flash meter.

## 2. Stroboscopic Flash With a Slave Unit

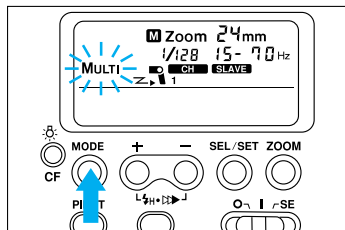

- While **M** is blinking, press the **<MODE>** button. **MULTI** will then start blinking.
- To set the stroboscopic flash, see page 46.



To determine the proper exposure, take test shots and experiment.



Pressing the **<MODE>** button while **MULTI** is blinking will cancel the slave unit's independent setting. Set it back to an independent setting.



An independent setting is retained even after the slave unit's main switch is set to **O**. When the main switch is set to **I** again, the independent setting takes effect.

## ● Speedlite Transmitter ST-E2 (Sold separately)

Speedlite Transmitter ST-E2 serves as the master unit for wireless Speedlite 550EX control. It can control up to two slave unit groups (A and B). It is attached directly to the camera's hot shoe. As a master unit, the differences between the 550EX and Speedlite Transmitter ST-E2 are listed below.

Wireless Functions	Unit	550EX	ST-E2
E-TTL autofocus		○	○
High-speed sync		○	○
FE lock		○	○
Flash exposure compensation		○	X*
FEB (Flash exposure bracketing)		○	X
Flash ratio control/Group control		○ / A, B, C	○ / A, B
Manual flash mode		○	X*
Stroboscopic flash		○	X*
Second-curtain sync		X	X
Modeling flash		○	○

\* Settable with the slave unit.

For details,  
see the Speedlite Transmitter  
ST-E2 Instructions.

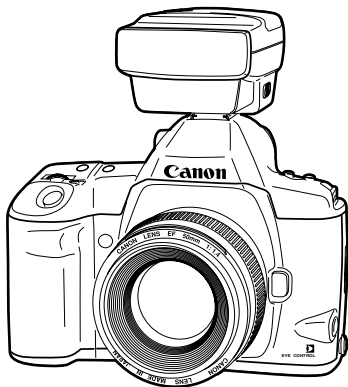

When using the Speedlite Transmitter ST-E2 with a Type-A camera, also read pages 112 to 125.

## For Type-B Cameras

# Basic Flash Photography

When the Speedlite 550EX is attached to a Type-B camera such as the EOS-1N, you can take flash pictures with TTL autoflash as easily as normal autoexposure (AE) pictures. Flash photography can be fully automatic—all you do is press the shutter button. Or you can set the desired shutter speed and aperture and still obtain autoflash exposure.

With the EOS-1N, the flash exposure is controlled by real-time, 3-zone, off-the-film TTL autoflash metering linked to the active focusing point.



- This section assumes that the Speedlite 550EX is used with the EOS-1N.
- Before proceeding, first turn on the EOS-1N and the 550EX.
- Set the 550EX's wireless selector to OFF.
- For EOS-1N operations, refer to the EOS-1N Instructions.

# 1. Using Flash in Full Auto Mode

Set the camera's picture-taking mode to **P** (Program AE) or  (Full Auto). Flash photography will then be as easy as normal AE photography. The camera sets the aperture and shutter speed automatically to suit a wide variety of lighting conditions including outdoor fill flash. The E-TTL autoflash system sets the flash exposure automatically.

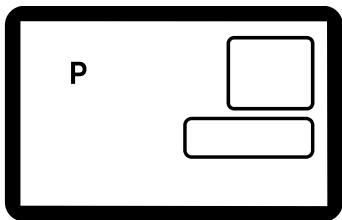

- 1 Set the camera's picture-taking mode to **P**.

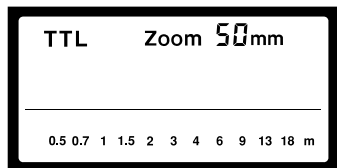

- 2 Set the 550EX's flash mode to **TTL**.

- 3 Focus the subject.

- The shutter speed and aperture will be displayed in the viewfinder.
- The shutter speed will be set automatically at 1/60 sec. or faster (up to the top sync speed). The aperture is also set at the same time.



- 4 Check that the subject is within the flash range displayed on the 550EX's LCD panel.



- 5 Check that the  icon is displayed in the viewfinder, then take the picture.

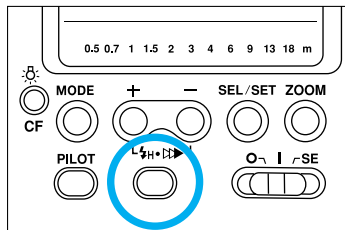

- 6 After the flash fires, check that the flash exposure confirmation lamp lights.

When a correct flash exposure has been obtained, the flash exposure confirmation lamp lights for about 3 sec. If the lamp does not light, the flash may have been insufficient, resulting in underexposure. In such a case, check that the pilot lamp is red, then move closer to the subject and take the picture again.

## ● Fill Flash

Fill flash can be used outdoors in daylight to supplement existing light. It can soften shadow areas of the subject or illuminate a backlit subject.



When fill flash is used, the flash exposure level is reduced automatically so that the subject's illumination by the flash balances well with the background's ambient light. Instead of having a properly-exposed subject and an underexposed background, both the subject and background are exposed correctly for a natural-looking flash picture.

## 2. Using Flash in Other Camera Modes

Flash photography is also automatic in the other picture-taking modes. In the **Av** (aperture-priority AE), **Tv** (shutter speed-priority AE), and **M** modes, the TTL autoflash system sets the flash exposure automatically. The camera sets the necessary shutter speed (in the Av mode), aperture (in the Tv mode), or flash output (in the M mode). Flash photography is as easy as normal AE picture-taking.

### Shutter Speed and Aperture Settings for Picture-Taking Modes

Camera Mode	Shutter Speed	Flash Aperture
<b>Av</b>	Automatically set (30 sec. - 1/X sec.)	Manually set
<b>Tv</b>	Manually set (30 sec. - 1/X sec.)	Automatically set
<b>M</b>	Manually set (bulb, 30 sec. - 1/X sec.)	Manually set

- Manually set: You set it yourself.
- Automatically set: Set automatically by the camera.
- 1/X sec.: Maximum sync speed. (See page 124).
- When the shutter button is pressed completely, the flash fires and the picture is taken. The flash output is controlled by the TTL autoflash system based on the aperture set by you or the camera. The TTL autoflash system meters the light reflected off the film during the exposure and cuts off the flash when the proper exposure is obtained.
- The background's exposure is set with the shutter speed and aperture combination.



- If the camera is set to the  mode (Full Auto), the shutter speed and aperture will be set in the same way as in the **P** mode (Program AE).
- If the **DEP** mode (depth-of-field AE) is used with the 550EX, it will be the same as using the **P** mode (Program AE).



## (1) Av: Aperture-Priority AE and TTL Autoflash

This mode is effective for controlling the depth of field in your flash pictures. You can also obtain a balanced exposure between the subject and background. You set the aperture and the camera sets the shutter speed automatically to obtain a correct exposure for the background. The TTL autoflash system obtains the proper exposure based on the aperture you set.

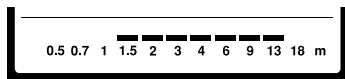
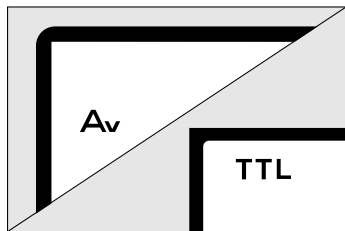

- 1 Set the camera's picture-taking mode to **Av**.
- 2 Set the 550EX's flash mode to **TTL**.
- 3 Focus the subject.
- 4 Check that the subject distance is within the flash range displayed on the 550EX's LCD panel.
- 5 Check that the ⚡ icon is displayed in the viewfinder, then take the picture.



If the top sync speed display blinks, the background will be overexposed. And if the 30" shutter speed display blinks, the background will be underexposed. In such cases, change the aperture until the shutter speed display stops blinking.

### ● Balanced Flash Exposures

In low-light situations, the exposure level can be balanced between the subject and background by using a slow sync speed. You can obtain balanced flash exposures automatically by setting the camera's picture-taking mode to Av. The camera then sets the sync speed automatically to suit the background. Using a tripod is recommended to prevent camera shake.



Balanced flash exposure.

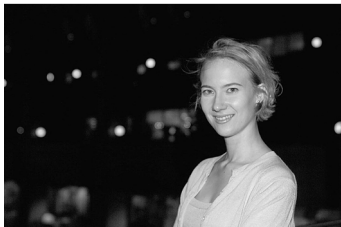

Flash exposure in the Full Auto mode.



- To disable automatic balanced flash exposures, set the camera's picture-taking mode to **M**. You can then set the desired shutter speed and aperture manually. See page 84.  
Based on the shutter speed and aperture you set, the TTL autoflash system controls the flash exposure automatically.
- If you are using the Canon EF 135mm f/2.8 soft focus lens on your camera without a tripod, setting the shutter speed and aperture manually is most effective for obtaining soft-focus effects. Follow the procedure below.
  - 1) Set an aperture near the maximum aperture.
  - 2) Set the minimum shutter speed required to prevent camera shake.
  - 3) Check that the flash has recharged, then take the picture.



- To obtain balanced flash exposures in the **Tv** mode, set the shutter speed until the meter reading indicates a correct exposure.
- To obtain balanced flash exposures in the **M** mode, set the shutter speed and aperture until the meter reading indicates a correct exposure.

## (2) Tv: Shutter Speed-Priority AE and TTL Autoflash

By selecting the shutter speed, you can obtain various effects with flash. You can set the shutter speed from 30 sec. to the top sync speed. The camera then sets the aperture automatically to obtain a correct exposure for the background. The TTL autoflash system controls the flash exposure based on the camera-selected aperture.

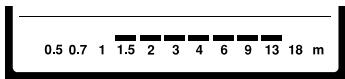
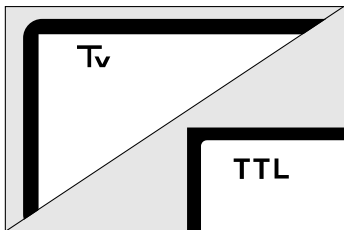

- 1 Set the camera's picture-taking mode to **Tv** and set the desired shutter speed anywhere from 30 sec. to the top sync speed.
- 2 Set the 550EX's flash mode to **TTL**.
- 3 Focus the subject.
- 4 Check that the subject distance is within the flash range displayed on the 550EX's LCD panel.
- 5 Check that the  icon is displayed in the viewfinder, then take the picture.



If the aperture display blinks, the background may turn out overexposed or underexposed. In such a case, change the shutter speed until the aperture display stops blinking.

### (3) M: Manual Exposure and TTL Autoflash

In this mode, you set both the shutter speed and aperture. The TTL autoflash system controls the flash exposure based on the aperture you set.

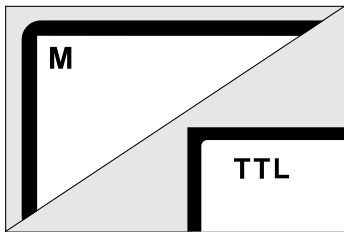

- 1 Set the camera's picture-taking mode to **M** and set the desired aperture and shutter speed anywhere from 30 sec. to the top sync speed. You can also use **buLb**.
- 2 Set the 550EX's flash mode to **TTL**.
- 3 Focus the subject.
- 4 Check that the subject distance is within the flash range displayed on the 550EX's LCD panel.
- 5 Check that the ⚡ icon is displayed in the viewfinder, then take the picture.

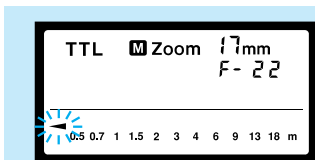

If the flash ranges below apply, the icon will blink on the left end of the scale. ◀

Zoom Setting	Flash Range
17-28mm	0.5 m / 1.6 ft or shorter
35mm and longer	0.7 m / 2.3 ft or shorter

## For Type-B Cameras

# Advanced Flash Photography

This section explains advanced flash operations possible with the Speedlite 550EX. It contains the following:

1. Flash Exposure Compensation (page 86)
2. FEB (Flash Exposure Bracketing) (page 88)
3. Bounce Flash (page 90)
4. Close-Distance Flash Photography (page 92)
5. Manual Flash Mode (page 93)
6. Stroboscopic Flash (page 95)
7. Second-Curtain Synchronization (page 98)



- This section assumes that the 550EX is used with an EOS-1N.
- Before proceeding, first turn on main switch on the EOS-1N and 550EX.
- Set the 550EX's wireless selector to OFF.
- For EOS-1N operations, refer to the EOS-1N Instructions.

# 1. Flash Exposure Compensation

Flash exposure compensation with the 550EX can be set up to  $\pm 3$  stops in 1/3-stop increments (or 1/2-stop increments with some cameras). You can also use flash exposure compensation in combination with normal exposure compensation (to control the background's exposure level) in a flash picture.

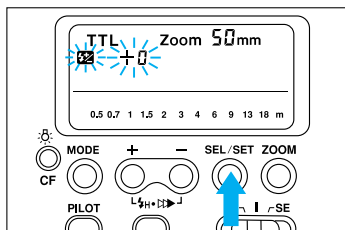

1 Press the **<SEL/SET>** button and select .

- Pressing the **<SEL/SET>** button changes the blinking setting in the following loop:

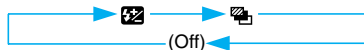

- The  icon and flash exposure compensation display blink.

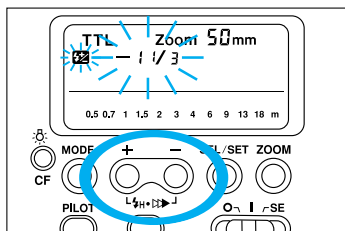

2 Press the **<+>** or **<->** button to set the desired flash exposure compensation amount.

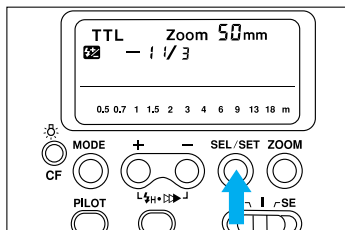

3 Press the **<SEL/SET>** button or press the shutter button halfway.

- The  icon and flash exposure compensation amount will stop blinking and remain displayed.

4 Focus the subject.

- Pressing the shutter button halfway also displays the flash exposure compensation amount on the scale in the viewfinder.



**5** Check that the subject is within the flash range displayed on the 550EX's LCD panel.



**6** Check that the  $\downarrow$  and  $\uparrow$  icons are displayed in the viewfinder, then take the picture.



- Flash exposure compensation set with the 550EX overrides any flash exposure compensation set with the camera.
- If the subject is small and the background is dark, flash exposure compensation may not give the desired result. In such a case, use the manual flash mode. See page 93.



### Effect on exposure of each type of compensation

	Effect
E-TTL flash exposure compensation	Changes the flash exposure of the main subject.
AE exposure compensation	Changes the exposure of the background.
Compensating the exposure by changing the film speed setting	Changes both the flash (main subject) exposure and the background exposure by the same amount.

## 2. FEB (Flash Exposure Bracketing)

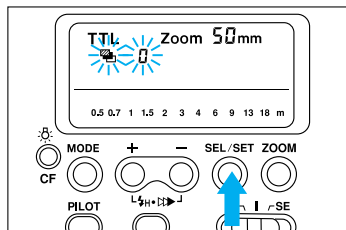

With FEB, you can obtain bracketed flash shots of the subject while the background exposure level remains the same. Three bracketed flash shots can be taken: Correct exposure, decreased exposure, and increased exposure. The three shots can be bracketed up to  $\pm 3$  stops in 1/3-stop increments (or 1/2-stop increments with some cameras). After all three bracketed flash shots are taken, FEB is canceled automatically.

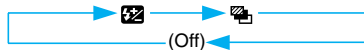

1 Press the **<SEL/SET>** button and select .

- Pressing the **<SEL/SET>** button changes the blinking setting in the following loop:



- The  icon and flash exposure bracketing display will blink.
- If the  icon appears, press the **<SEL/SET>** button again.

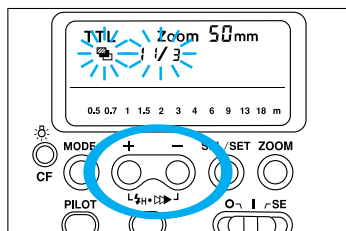

2 Press the **<+>** or **<->** button to set the flash exposure bracketing amount.

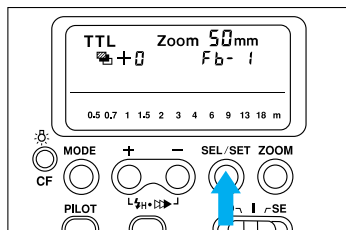

3 Press the **<SEL/SET>** button.

- The 550EX's LCD panel display will be similar to the figure on the left.

4 Focus the subject.



- When the shutter button is pressed halfway, the  icon will be displayed on the viewfinder bottom.

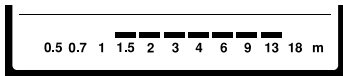

## FEB (Flash Exposure Bracketing)



**5** Check that the subject is within the flash range displayed on the 550EX's LCD panel.

**6** Check that the  and  icons are displayed in the viewfinder, then take the picture.

**7** Take the remaining two bracketed shots. (If necessary, repeat steps 4 to 6.)



Correct exposure.





Decreased exposure by 1 stop.



Increased exposure by 1 stop.



- The film advances according to the camera's current film advance mode.
- Before taking the picture, make sure the flash is ready by checking that the 550EX's pilot lamp is red or the  icon is displayed in the viewfinder. If the flash is not ready, only normal AE mode pictures can be taken. The  (single-frame) film advance mode is recommended.
- When the flash is ready, you can continue taking the bracketed flash shots.

**CF**

Custom Function CF-1 can prevent the FEB setting from canceling automatically after the three bracketed flash shots are taken. See page 113.

**CF**

Custom Function CF-2 can change the sequence of the bracketed flash shots. See page 113.

## 3. Bounce Flash

With direct, frontal flash, harsh shadows are usually created in the background behind the subject. This can be avoided by bouncing the flash off a nearby wall or ceiling. Bounce flash also gives softer lighting effects.

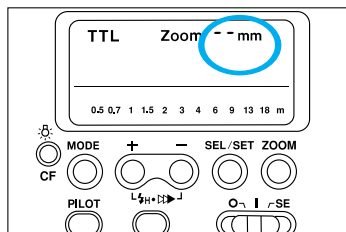
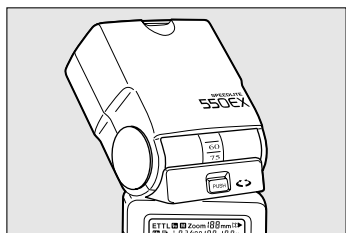
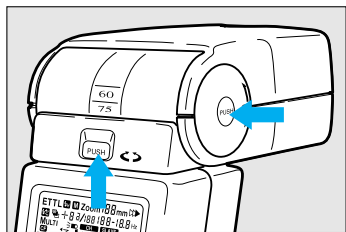

- 1 To turn the flash head, press the **<PUSH>** button. To tilt the flash head, press the **<TTL>** button. Turn and/or tilt the flash head and point it at a wall, ceiling, or other reflective surface.

The flash head can be pointed in the directions and angles listed below.

Direction	Maximum Angle	Click Stops
Up	90°	0°, 60°, 75°, 90°
Down*	7°	0°, 7°
Left	180°	0°, 60°, 75°, 90°, 120°, 150°, 180°
Right	90°	0°, 60°, 75°, 90°

\* See page 92.

- 2 When the flash head is turned or tilted, **-- mm** is displayed on the 550EX's LCD panel.

- When the flash head's zoom setting is automatic and the flash head is turned or tilted, the zoom setting is set automatically to 50mm. The zoom setting can also be set manually for bounce flash.
- If a manual zoom setting **M** has been set, the zoom setting display does not change when the flash head is turned or tilted.

- 3 Focus the subject.



**4** Check that the ⚡ icon is displayed in the viewfinder, then take the picture.

- If the flash exposure confirmation lamp does not light after you take the picture, use a larger aperture (smaller f-number) and try again.



Bounce the flash on a plain, white, reflective surface. If a colored surface is used, the picture may have a color cast.



With bounce flash.



Without bounce flash.





### ● Creating a Catchlight

A catchlight is a reflection of the flash in the subject's eyes. A catchlight in the eyes makes the subject look more lively. For portraits, you can easily create a catchlight with the 550EX. See page 42.

## 4. Close-Distance Flash Photography

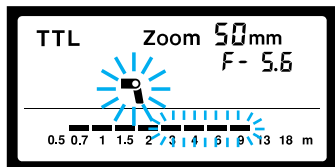
The flash head can be tilted downward by 7°. This position enables the flash to better illuminate the lower part of a subject that is close to the camera.



Press the  $\langle \text{FLASH} \rangle$  button and tilt the flash head downward until it stops. The  icon will blink on the LCD panel.

- This flash head position is effective only for subjects 0.5 meter / 1.6 ft to 2 meters / 6.6 ft from the camera.
- The flash range will be displayed as shown in the left figure.

## 5. Manual Flash Mode

In the manual flash mode, you can set the flash output from 1/1 (full) to 1/128 power in full-stop increments.

- To prevent overheating and deterioration of the flash head, observe the following limits for continuous shooting with flash:

(1) At 1/1 or 1/2 output:	Max. 15 continuous flash shots.
(2) At 1/4 or 1/8 output:	Max. 20 continuous flash shots.
(3) At 1/16 or 1/32 output:	Max. 40 continuous flash shots.

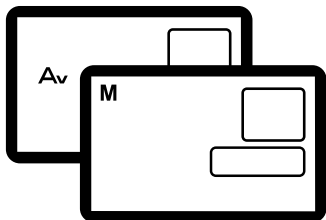

- 1 Set the camera's picture-taking mode to **Av** or **M**.

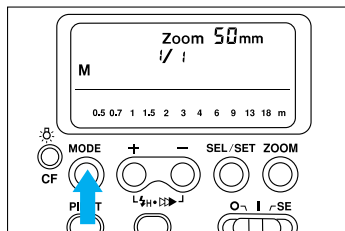

- 2 Press the 550EX's **<MODE>** button and select **M**.

- Pressing the **<MODE>** button changes the flash mode in the following loop:

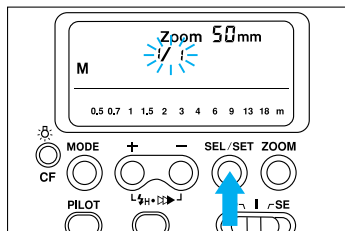
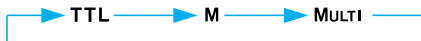

- 3 Press the **<SEL/SET>** button.

- The manual flash output display blinks.

## Manual Flash Mode

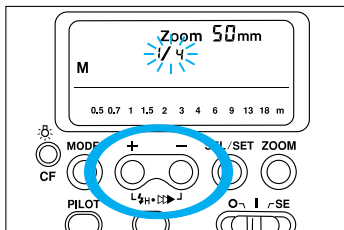

**4** Press the <+> or <-> button to set the desired flash output.

- Each time the button is pressed, the flash output changes by one stop.

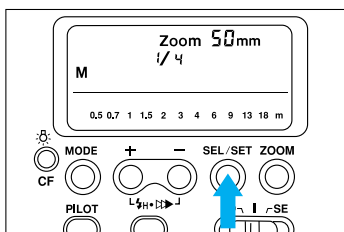

**5** Press the <SEL/SET> button again. The manual flash output display will stop blinking and remain displayed.

**6** Focus the subject.

- When you press the shutter button halfway, focus will be achieved and the aperture and flash range (bar segment) will be displayed on the LCD panel.

**7** Check the focusing distance on the lens.

**8** Check the flash range on the LCD panel. If the flash range does not match the focusing distance, change the aperture until it does match.

- You can also change the flash output until the flash range matches the focusing distance.



**9** Check that the ⚡ icon is displayed in the viewfinder, then take the picture.



- If there is a large difference between the flash range and focusing distance, change the flash output or use a larger aperture until they match.
- To obtain a more precise flash exposure, use a hand-held flash meter.

## 6. Stroboscopic Flash

With stroboscopic flash, a rapid series of flashes is fired. It can be used to record multiple images of a moving subject in a single photograph for later study.

You can set the firing frequency (the number of flashes per sec. expressed as Hz) from 1 Hz to 199 Hz. The firing frequency can be set in 1-Hz increments from 1 Hz to 20 Hz, in 5-Hz increments from 25 Hz to 50 Hz, and in 10-Hz increments from 60 Hz to 199 Hz.

- Stroboscopic flash cannot be used with the EOS 750 and EOS 850 cameras.

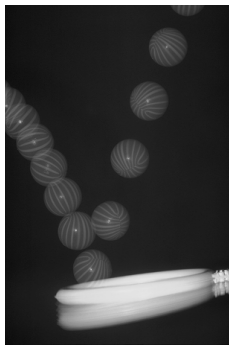

Up to 100 flashes can be fired continuously. This maximum varies depending on the flash output and firing frequency. See “Maximum Continuous Flashes” on page 122.

### ● Setting the Firing Frequency, Flash Count, and Flash Output

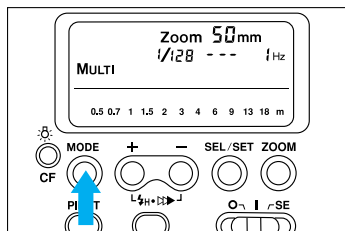

- 1 Press the **<MODE>** button and select **MULTI**.

- Pressing the **<MODE>** button changes the flash mode in the following loop:

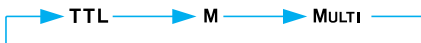

## Stroboscopic Flash

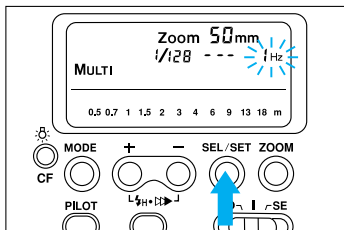

- 2 Press the **<SEL/SET>** button to select the firing frequency, flash count, or flash output display. When selected, the respective item blinks on the LCD panel to indicate that it can be altered. Pressing the **<SEL/SET>** button changes the blinking item in the following loop:

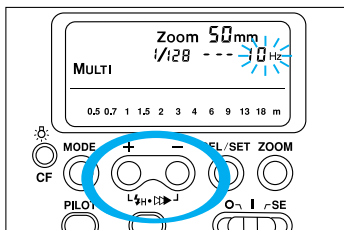
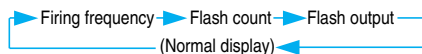

- 3 Press the **<+>** or **<->** button to set the desired value for the blinking item.

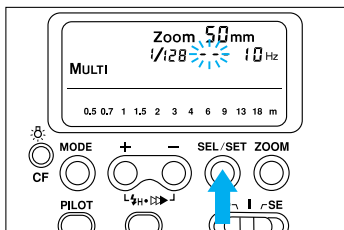

- 4 Press the **<SEL/SET>** button again to register the value. The item will then stop blinking and remain displayed. The next item will then start blinking. Repeat steps 3 and 4 to set the next item.

- After you set the flash output and press the **<SEL/SET>** button, the firing frequency, flash count, and flash output are displayed.

## ● Shooting With Stroboscopic Flash

To shoot with stroboscopic flash, you must set a shutter speed that gives the 550EX enough time to fire according to the firing frequency and flash count you have set.

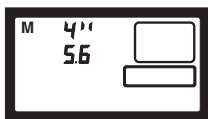

- 1 Set the camera's picture-taking mode to **M** and set the desired aperture.



- 2** Use the following formula to calculate the required shutter speed.

$$\begin{aligned} & \text{Flash count} \div \text{Firing frequency} \\ & = \text{Shutter speed} \end{aligned}$$

**Example:** If the flash count is 10 and the firing frequency is 5 Hz, the shutter speed will have to be at least 2 sec.

$$10 \div 5 = 2$$

- If the flash count display is --, the flash will keep firing until the shutter speed ends or until the maximum number of continuous flashes (as indicated in the table on page 122) is fired.

- 3** Focus the subject.

- To set the exposure settings, see "Manual Flash Mode" on page 93.

- 4** Check that the  icon is displayed in the viewfinder, then take the picture.



To prevent overheating and deterioration of the flash head, do not use stroboscopic flash for more than 10 frames in rapid succession. After 10 frames, allow the 550EX to cool for at least 10 minutes.



- Stroboscopic flash is most effective with highly reflective subjects in front of a dark background.
- Using a tripod and Remote Switch are recommended.
- Using an external power source is recommended for stroboscopic flash.



- Stroboscopic flash cannot be used at a flash output of 1/1 or 1/2.
- **buLb** can also be used with stroboscopic flash.

## 7. Second-Curtain Synchronization

Normally, the flash fires in synchronization with the first shutter curtain when the shutter is fully open. With second-curtain synchronization, the flash fires immediately before the second shutter curtain closes at the end of the exposure. With second-curtain synchronization and a slow shutter speed, you can create a trailing blur (illuminated by ambient light) that trails a moving subject (illuminated by the flash) to give a natural-looking illusion of motion.

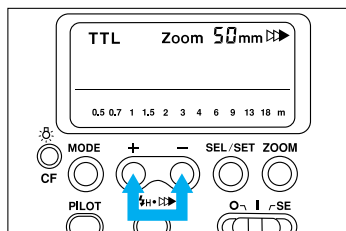

- 1 Set the desired picture-taking mode with the camera.
- 2 Press the **<+>** and **<->** buttons simultaneously to select **D▶▶** on the LCD panel.
  - Each time you press the **<+>** and **<->** buttons simultaneously, the display changes in the following loop:



- 3 Check that the **⚡** icon is displayed in the viewfinder, then take the picture.



With second-curtain synchronization.



With first-curtain synchronization.



- Second-curtain synchronization is easier with **bulb**.
- Second-curtain synchronization does not work with the camera's **□** picture-taking mode and Programmed Image Control modes.
- To cancel second-curtain synchronization, press the **<+>** and **<->** buttons simultaneously to turn off the **D▶▶** icon on the LCD panel.

## For Type-B Cameras

# Wireless Flash Photography

This section covers wireless flash photography with the 550EX. It explains the 550EX's built-in master and slave flash features. A wireless flash system with multiple Speedlite 550EXs can be used as easily as a single, on-camera Speedlite 550EX.

With Type-B cameras, the 550EX offers the following wireless flash features:

- [1] Wireless System Setup and Testing (page 100)
- [2] Wireless Manual Flash (page 107)
- [3] Wireless Stroboscopic Flash (page 109)
- [4] Independent Settings With a Slave Unit (page 110)



- This section assumes that the Speedlite 550EX is used with the EOS-1N.
- Before proceeding, first turn on the main switch on the EOS-1N and 550EX.
- In these Instructions, a Speedlite 550EX whose wireless selector has been set to < **MASTER** > is called the “master unit” and a 550EX whose wireless selector has been set to < **SLAVE** > is called a “slave unit.”
- For EOS-1N operations, refer to the EOS-1N Instructions.

## [1] Wireless System Setup and Testing

The wireless flash system can be setup in one of two ways: ① With a 550EX set as the master unit and one or more 550EXs set as slave units. ② With Speedlite Transmitter ST-E2 (sold separately) used as the master unit and one or more 550EXs set as slave units.

This section describes the procedure for the former. For the latter, refer to "[4] Manual or Stroboscopic Flash With a Slave Unit" on page 110,111.

### 1. Setting the 550EX as the Master Unit



Attach the 550EX to the camera and set the wireless selector to **MASTER**. This 550EX will then be the “master unit.” The master unit’s wireless signal is transmitted to the slave unit(s) at almost the same time as the shutter release.



The master unit’s flash head zoom setting is set automatically to **M 24mm**. This gives the wireless signal the maximum coverage of 80°. You can also press the **Zoom** button to change the zoom setting manually. However, this will narrow the wireless signal’s coverage.

### 2. Setting the 550EX as a Slave Unit



Set the wireless selector to **SLAVE** on the 550EX to be used as a slave unit. A 550EX set in this way is called a “slave unit.”

- The slave unit’s flash head zoom setting is set automatically to **M 24mm**.



You can change the slave unit’s flash head zoom setting manually with the **ZOOM** button.

### 3. Setting the Master/Slave Channel

To prevent your master unit from firing another photographer's slave units, four channels are provided to differentiate your slave units from unrelated ones. The master unit and slave unit(s) in the same wireless flash system must be set to the same channel No.

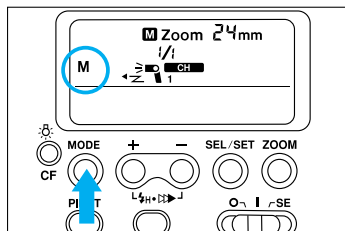

**1** Press the master unit's **<MODE>** button and select **M** or **MULTI**.

- The TTL mode cannot be used with wireless flash photography.

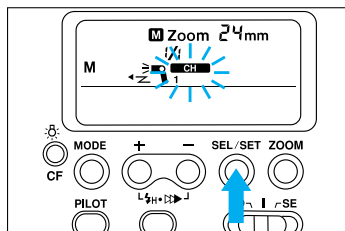

**2** To set the master unit's channel No., press the **<SEL/SET>** button and select **CH**.

- Pressing the **<SEL/SET>** button changes the selection in the following loop:

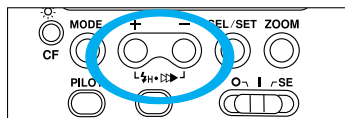
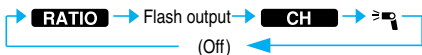

**3** Press the **<+>** or **<->** button to set the channel No. (1, 2, 3, or 4).

## Setting the Master/Slave Channel

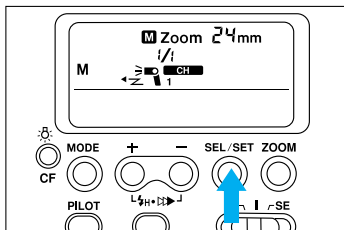

### 4 Press the <SEL/SET> button.

- The **CH** icon and channel No. will be displayed.

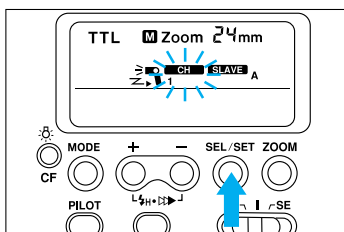

### 5 To set the slave unit's channel No., press the <SEL/SET> button and select **CH**.

- Pressing the <SEL/SET> button changes the selection in the following loop:

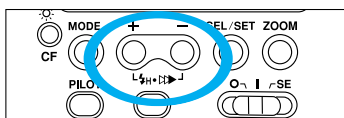

### 6 Press the <+> or <-> button to set the same channel No. (1, 2, 3, or 4) as the master unit's.

### 7 Press the <SEL/SET> button.

- The **CH** icon and channel No. will be displayed.



If the master unit and slave unit(s) are not set to the same channel No., the master unit will be unable to trigger the slave unit's flash. Make sure the channel No. is the same.

## 4. Setting the Slave ID

With multiple slave units, a slave ID can be assigned to distinguish a slave unit as being the main flash or fill flash. A flash ratio can thereby be set. Three slave IDs are available: A, B, and C.

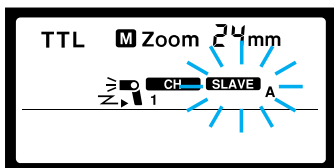

**1** To set a slave unit's slave ID, press the **<SEL/SET>** button and select **SLAVE**.

- Pressing the **<SEL/SET>** button changes the selection in the following loop:



**2** Press the **<+>** or **<->** button to set the slave ID (A, B, or C).

**3** Press the **<SEL/SET>** button.





- The **CH** icon and slave ID will be displayed.



If you want all the slave units to fire at the same flash output, you need not assign a slave ID.

## 5. Master Flash ON/OFF

The master unit's flash firing can be enabled (ON) or disabled (OFF).

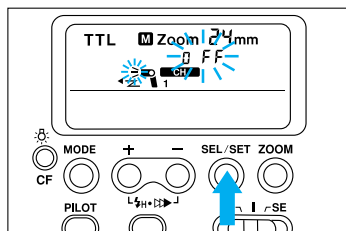

-  (  ON ) : This setting enables the master unit to fire a flash.
  - This setting is called "Master flash ON."
  - This setting automatically sets the master unit's slave ID to A.
-  (  FF ) : This setting (Master flash OFF) prevents the master unit from firing a flash. It can still transmit wireless signals to trigger the slave units.



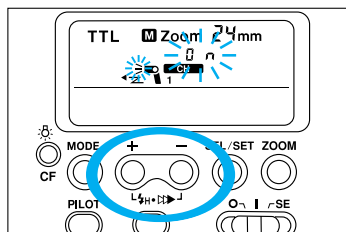

- Press the **<SEL/SET>** button and select .

- Pressing the **<SEL/SET>** button changes the selection in the following loop:



- Press the **<+>** or **<->** button to set either  ON or  FF.

- Press the **<SEL/SET>** button.

-  or  will appear.
- If master flash OFF is set,  will blink.



## 6. Wireless Flash Range

After the master and slave units have been set, position them within the wireless flash range shown below.

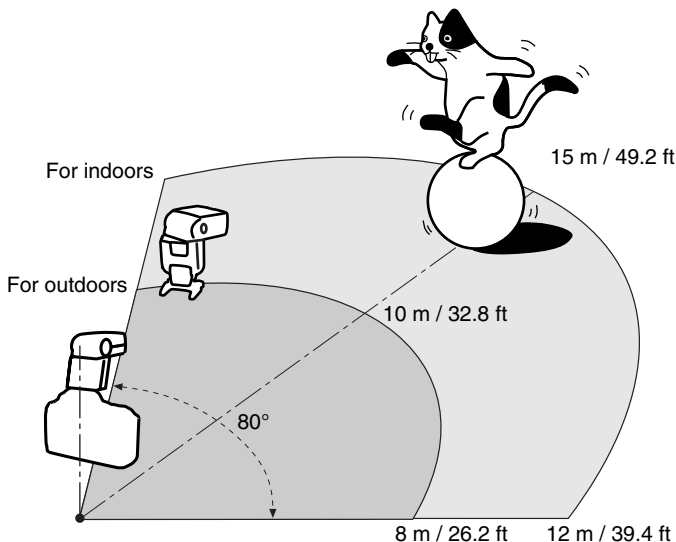

- Use the mini stand (provided) for the slave unit(s). The mini stand also has a tripod socket.
- Use the bounce feature to turn the body of the slave unit so that the sensor is exposed to the master unit.
- For an indoor setup, the positioning can be less precise since the wireless signals can bounce off the walls.
- After positioning the master and slave unit(s), fire a test flash to make sure the wireless flash system works.
- Do not place any objects between the master unit and slave unit(s) which may obstruct the wireless transmission.

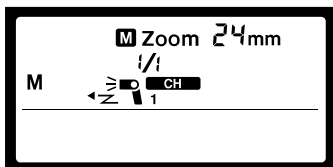

- 1 Set the master unit's flash mode to M.
- 2 Set the camera as desired for flash photography.

## Wireless Flash Range

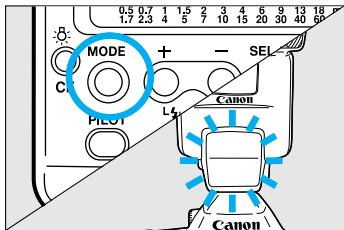

**3** Check that the master unit's pilot lamp is lit and that the slave unit(s) are recharged and ready.

- When a slave unit is ready, its AF-assist beam blinks once per second.

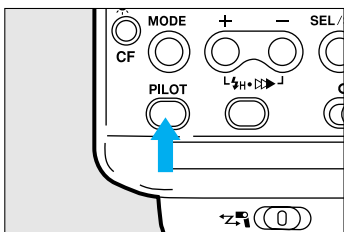

**4** Press the master unit's pilot lamp (test firing button) to fire a test flash.

- When the wireless transmission works, the slave unit fires at the flash output that was set.
- If a slave unit does not fire, place it closer to the master unit or angle the sensor more toward the master unit and try again.



- In a wireless flash system, all the settings can be set with the master unit. The master unit transmits all these settings to the slave units by wireless signals. Controlling slave unit(s) is the same as controlling one on-camera Speedlite.
- Make sure the slave units are within the effective range of the master unit.
- After the picture is taken, the slave unit's operation result is displayed on the LCD panel.
- With the slave unit's main switch set to SE (Save Energy), the slave unit turns off automatically if it is left unused for over 60 minutes\*. While the slave unit is off due to this SE mode, SE is displayed on the LCD panel. Within 1 hour\*\* after the slave unit turns off in the SE mode, the slave unit can be turned on again by pressing the master unit's test firing button.
- If the manual flash mode has been set and you press the master unit's pilot lamp, all the slave units will fire a test flash simultaneously at the manually-set flash output.
- After pressing the shutter button halfway, test firing cannot be executed during the first 6 sec. when the camera is metering the scene.

CF

\* Custom Function CF-4 can change this to 10 minutes. See page 113.

\*\* Custom Function CF-5 can change this to 8 hours. See page 113.

## [2] Wireless Manual Flash

After setting up the wireless flash system, you can manually set the slave unit's flash output with the master unit. The flash output can be uniform or varied among the slave units. To determine the proper flash exposure, use a hand-held flash meter.

### 1. Wireless Manual Flash With Uniform Flash Output

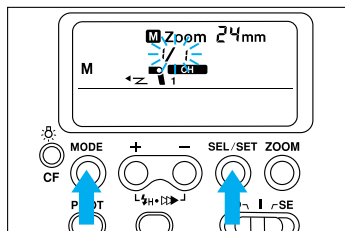

**1** Press the master unit's **<MODE>** button and select **M**.

**2** Press the **<SEL/SET>** button and select the flash output display.

- Pressing the **<SEL/SET>** button changes the selection in the following loop:

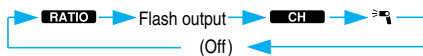

**3** Press the **<+>** or **<->** button to set the flash output.

**4** Press the **<SEL/SET>** button.

- The flash output will be displayed.

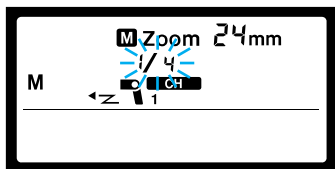

- When you take the picture, all the slave units will fire at the flash output you have set with the master unit.
- If master flash ON is set, the master unit will also fire at the same flash output.
- If a slave group is used, all the slave units in the group will fire at the flash output you have set with the master unit.

## 2. Wireless Manual Flash With Varied Flash Output

You can set a different flash output for each slave unit (A, B, and C) as follows.

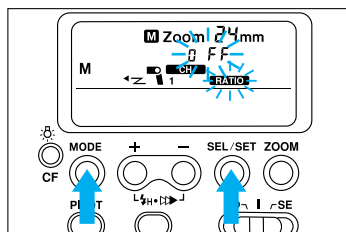

1 On the master unit, press the <MODE> button.

2 Press the <SEL/SET> button and select **RATIO**.

- Pressing the <SEL/SET> button changes the selection in the following loop:

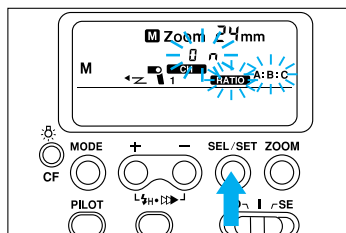
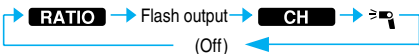

3 Press the <-> button to select **RATIO ON A:B** or **A:B:C**.

- RATIO ON A:B** or **A:B:C** will blink.

4 Press the <SEL/SET> button.

- A** and the flash output display will blink.

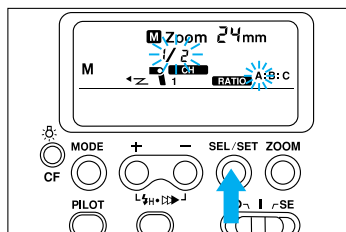

5 Press the <+> or <-> button to set the flash output for **A**.

6 Press the <SEL/SET> button.

- B** and the flash output display will blink.

## Wireless Manual Flash With Varied Flash Output

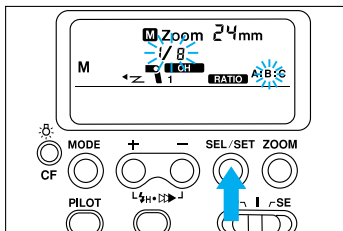

7 Press the **<+>** or **<->** button to set the flash output for **B**.

8 Press the **<SEL/SET>** button.  
• **C** and the flash output display will blink.

9 Press the **<+>** or **<->** button to set the flash output for **C**.

10 Press the **<SEL/SET>** button to register the settings.

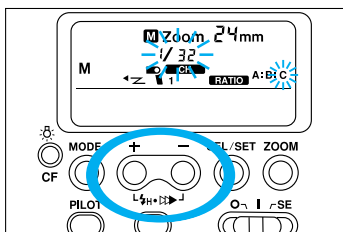

- If there are only two slave units (A and B), steps 9 and 10 may be omitted.
- After you complete the settings, you can check the respective flash output for slave units A, B, and C by pressing the **<+>** or **<->** button.
- Press the master unit's pilot lamp to test fire the slave units.

## [3] Wireless Stroboscopic Flash

After setting up the wireless flash system, you can set stroboscopic flash with the master unit for wireless stroboscopic flash.

- The firing frequency and flash count will be the same for all slave units. They can be set by following the procedure on page 97.
- Set the flash output of the slave units in the same way as for wireless manual flash. See page 93.
- To determine the proper exposure, take test shots and experiment.

## [4] Manual or Stroboscopic Flash With a Slave Unit

Manual flash or stroboscopic flash can be set manually with a slave unit. The setting is independent from the master unit. The master unit just triggers the slave unit which fires according to its own independent (manual or stroboscopic flash) setting. This feature can be used in the following situations:

- (1) As with studio flash, you can set the slave unit's flash output yourself for wireless manual flash photography.
- (2) For wireless manual flash photography with Wireless Transmitter ST-E.

### 1. Manual Flash With a Slave Unit

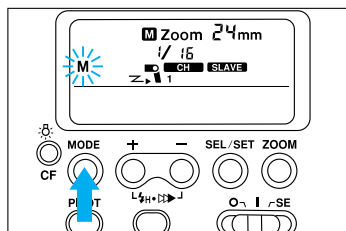

On a slave unit with the wireless selector set to <SLAVE>, press the <MODE> button for at least 2 sec.

**M** will start blinking. It will continue to blink while the slave unit's independent setting is in effect.

To set the flash output, see page 93.



To determine the proper flash exposure, use a hand-held flash meter.

## 2. Stroboscopic Flash With a Slave Unit

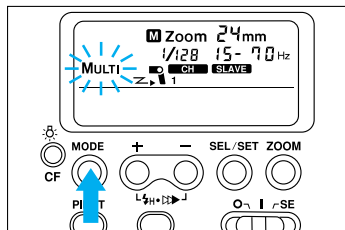

- While **M** is blinking, press the **<MODE>** button. **MULTI** will then start blinking.
- To set the stroboscopic flash, see page 95.



To determine the proper exposure, take test shots and experiment.



Pressing the **<MODE>** button while **MULTI** is blinking will cancel the slave unit's independent setting. Set it back to an independent setting.



An independent setting is retained even after the slave unit's main switch is set to **O**. When the main switch is set to **I** again, the independent setting takes effect.

# Custom Functions

The Speedlite 550EX has Custom Functions which enable you to customize Speedlite functions according to your preferences.

## ● Setting a Custom Function

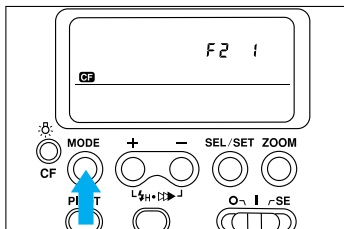

- 1 Press the LCD panel illumination button for at least 2 sec. until **CF** appears on the LCD panel.
- 2 Press the **<SEL/SET>** button until the Custom Function No. to be altered blinks.
  - Pressing the **<SEL/SET>** button selects the Custom Function No. from F1 to F6.
- 3 Press the **<+>** or **<->** button to set the Custom Function setting to 0 or 1 according to your preference.
- 4 Press the **<SEL/SET>** button.
  - The display stops blinking.
- 5 Press the LCD panel illumination button or the **<MODE>** button to return to the normal state.
  - You need not press the LCD panel illumination button for 2 sec. or longer.



- A Custom Function can be set while the wireless selector is set to **OFF** or **MASTER**.
- When a Custom Function has been set, the **CF** icon is displayed on the LCD panel.



## ● Custom Function Settings

Function	Custom Function No.	Setting	Description
FEB cancellation after completion	CF-1	0	Enabled
		1	Disabled
FEB sequence	CF-2	0	Correct exposure, decreased exposure, increased exposure
		1	Decreased exposure, correct exposure, increased exposure
Flash metering system	CF-3	0	E-TTL
		1	TTL
Slave unit SE mode activation	CF-4	0	Activate after 60 min. of non-operation.
		1	Activate after 10 min. of non-operation.
Slave unit SE mode cancellation	CF-5	0	Enable SE mode cancellation by master unit for 1 hour.
		1	Enable SE mode cancellation by master unit for 8 hours.
Modeling flash	CF-6	0	Enabled
		1	Disabled



- With a Type-A camera, the CF-3-1 setting will not enable wireless operation with autoflash.
- With a Type-B camera, TTL autoflash will be set regardless of the CF-3 setting.

# Canon Speedlite 550EX System

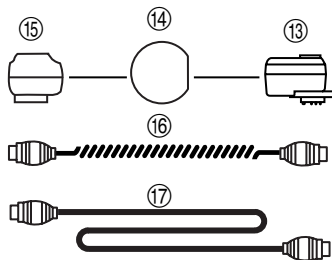
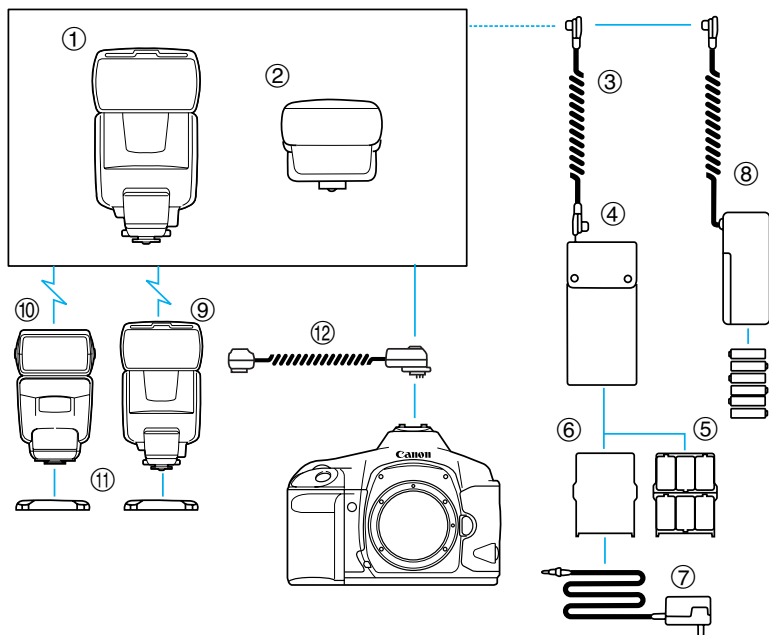

The accessories on the left enable wired, multi-Speedlite TTL autoflash.

- ⑬ TTL Hot Shoe Adapter 3
- ⑭ TTL Distributor
- ⑮ Off-Camera Shoe Adapter OA-2
- ⑯ Connecting Cord 60
- ⑰ Connecting Cord 300

- ① **Speedlite 550EX** (On-camera master unit)
- ② **Speedlite Transmitter ST-E2**  
Dedicated wireless transmitter for any 550EX set as a slave unit.
- ③ **Connecting Cord ET** (included with Transistor Pack E)
- ④ **Transistor Pack E**  
Houses Battery Magazine TP or Ni-Cd Pack TP.
- ⑤ **Battery Magazine TP**  
Houses six size-C alkaline batteries.
- ⑥ **Ni-Cd Pack TP**  
Ni-Cd pack dedicated to Transistor Pack E.  
Shortens flash recycle time as with a high-voltage battery. Rechargeable with Ni-Cd Charger TP for repeated use.
- ⑦ **Ni-Cd Charger TP**  
Dedicated charger for Ni-Cd Pack TP. Charging time is about 15 hours.
- ⑧ **Compact Battery Pack CP-E2**  
Small and lightweight external power source. It uses six size-AA alkaline or nickel-hydride batteries. It can also use lithium batteries.
- ⑨ **Speedlite 550EX** (Slave unit)
- ⑩ **Speedlite 420EX** (Slave unit)
- ⑪ **Mini Stand** (provided with the 550EX and 420EX)  
Mini stand to prop up the 550EX or 420EX positioned as a remote slave unit.  
Tripod socket provided at the bottom.
- ⑫ **Off-Camera Shoe Cord 2**  
For off-camera flash operation up to 60 cm away from the camera. All automatic EOS functions are enabled

# Troubleshooting Guide

No.	Problem	Probable Cause	Solution	Page
1	I cannot detach the Speedlite from the camera.	The locking collar has not been loosened enough to retract the locking pin.	Loosen the locking collar completely to retract the locking pin.	13
2	The flash does not fire even when I press the shutter button completely.	The Speedlite has not been mounted properly on the hot shoe.	Mount the Speedlite properly and securely on the camera.	13
		The hot shoe contacts are dirty or the Speedlite's mounting foot contacts are dirty.	If the contacts are dirty, use a clean cloth to wipe them.	13
3	After I turn on the Speedlite, the pilot lamp turns off after a while.	With the main switch set to SE, the Speedlite turns off automatically when it is not used for 90 sec.	Press the shutter button halfway or press the test firing button.	16
4	When I turn on the main switch, the entire display blinks.	The wide panel is not fully retracted.	Retract the wide panel completely.	20 42
		The wide panel has been extended and the Speedlite is set for bounce flash.	Retract the wide panel.	20
5	When I press the shutter button halfway, the flash range bar segments blink.	The flash head has been tilted downward by 7°.	Except for close-distance subjects, do not tilt the flash head downward.	43 92
6	I installed new batteries in the external power source, but the flash still does not fire.	Batteries have not been installed in the 550EX itself. Or, the batteries in the 550EX are exhausted.	Even when using an external power source, be sure to have good batteries in the 550EX.	10
7	I installed new batteries in my external power source and connected it to the Speedlite. When I turned on the power switch, the flash head zoomed automatically. Or the LCD panel display went out.	The batteries in the 550EX are exhausted. Disconnect the external power source and turn on the 550EX. If the pilot lamp does not light within 30 sec., the 550EX's batteries are exhausted.	Replace the batteries in the 550EX with new ones.	10
8	The flash picture looks dark toward the bottom.	The subject was too close to the camera.	If the subject is 2 meters or closer, tilt the flash head downward by 7°.	43 92

No.	Problem	Probable Cause	Solution	Page
9	The subject was toward the edge of the picture and it came out overexposed.	The subject was not correctly exposed with the flash.	With an EOS camera having multiple focusing points, select a focusing point which covers the subject and then compose the shot before taking the picture. With an EOS camera having only one focusing point, set a suitable exposure compensation amount on the minus side.	36 86
10	The subject was in front of a window and the subject's face turned out dark.	The flash's reflection in the window caused the underexposure.	Position yourself or the subject so that the flash's reflection in the window does not enter the picture. Or set exposure compensation on the plus side.	36 86
11	A group picture of people wearing black clothing had overexposed faces.	The Speedlite tried to obtain a correct exposure for the black clothing which has low reflectance.	Set exposure compensation on the minus side.	36 86
12	The periphery of the picture came out dark.	The flash head's zoom setting that you set manually gave inadequate flash coverage for the lens focal length.	Set the flash head to auto zoom. Or manually set a zoom setting that is shorter than the lens focal length.	18
13	The picture looks overexposed or underexposed.	Flash exposure compensation was still in effect.	Cancel the flash exposure compensation setting.	36 86
14	The picture came out blurred.	Since the camera was set to the <b>Av</b> mode and the scene was dark, a slow shutter speed was set automatically. During the slow exposure, camera shake caused the blurry photograph.	<ol style="list-style-type: none"> <li>(1) Using a tripod is recommended.</li> <li>(2) Use the P mode.</li> <li>(3) Use the M mode on the camera</li> </ol>	28 82
15	The slave unit does not fire.	The slave unit's wireless selector is not set to <b>SLAVE</b> .	Set the slave unit's wireless selector to <b>SLAVE</b> .	53 100
		The slave unit is not within the master unit's wireless transmission range.	Position the slave unit within the wireless transmission range.	58 105

# Specifications

Type: Direct-sync, shoe-mount flash with E-TTL/TTL autoflash control and wireless transmission/reception (E-TTL preflash, AF-assist beam, auto zoom, and bounce flash).

Compatible cameras: Type-A EOS cameras (for E-TTL autoflash control)  
Type-B EOS cameras (for TTL autoflash control)

Flash coverage and Guide No.: See page 121.

Battery life and recycling time: See page 11.

Flash duration: 1.2 ms or less. For quick flash: 2.3 ms or shorter.

Flash coverage: (1) Auto zoom head covers 24mm, 28mm, 35mm, 50mm, 70mm, 80mm, and 105mm lens focal lengths automatically.  
(2) Manual zoom: Enabled with zoom button.  
(3) Wide panel: When the built-in wide panel covers the flash head, flash coverage is extended for 17mm lens focal length.

Flash modes: (1) Normal flash  
(2) Quick flash  
(3) High-speed sync (FP flash)  
(4) Stroboscopic flash: 41 flash frequency settings, 31 firing settings  
(5) Preflash: Obtains exposure reading for E-TTL autoflash control  
(6) Test flash: With test firing button  
(7) Modeling flash: Fired with the camera's depth-of-field preview button

Bounce positions:

Direction	Angle	Click Stops
Up	0° - 90°	0°, 60°, 75°, 90°
Down	0° - 7°	0°, 7°
Left	0° - 180°	0°, 60°, 75°, 90°, 120°, 150°, 180°
Right	0° - 90°	0°, 60°, 75°, 90°

Exposure control modes: (1) E-TTL autoflash (with Type-A cameras: Preflash evaluative metering)  
(2) FE lock (with Type-A cameras: Preflash metering, FE lock)  
(3) TTL autoflash (with Type-B cameras: Off-the-film metering)

Flash exposure compensation:

(1) Automatic flash output reduction for fill flash.  
(2) Flash exposure compensation adjustable manually with the Speedlite up to  $\pm 3$  stops in 1/3- or 1/2-stop increments.  
(3) Flash exposure compensation adjustable manually up to  $\pm 3$  stops in 1/3- or 1/2-stop increments with cameras equipped with flash exposure compensation function.

FEB: Set with the Speedlite up to  $\pm 3$  stops in 1/3-stop or 1/2-stop increments.

Flash range (with 50mm f/1.4 lens at ISO 100):

(1) With normal flash : 0.5 - 30 meters / 1.6 - 100 feet  
(2) With quick flash : Min. 0.5 - 7.5 meters and max. 0.5 - 21 meters /  
: Min. 1.6 - 25 feet and max. 1.6 - 70 feet  
(3) With high-speed sync : 0.5 - 15 meters / 1.6 - 49 feet (at 1/250 sec.)

Flash exposure confirmation: Yellow-green pilot lamp lights.

Sync speed: See page 124.

- Flash-ready indication: (1) Red pilot lamp indicates normal flash ready.  
(2) Yellow pilot lamp indicates quick flash ready.
- AF-assist beam linkage and range:  
Linked to area AF (45 focusing points), effective from approx. 0.6 to 10 meters / 2 to 33 feet at the center and 0.6 to 5 meters / 2 to 16 feet along the periphery (in total darkness).
- Wireless functions
- Transmission system: Optical pulse transmission
- Configuration: Camera, master unit, and slave unit(s)
- Wireless switchover: With wireless selector
- Wireless selector positions:  
OFF, Master, Slave
- Channels:  
4
- [Master unit]
- Transmission angle: Horizontal: Approx. 80° / Vertical: Approx. 60° (At **M** 24mm zoom setting)  
(Manual zooming of flash head also enabled)
- Transmission range: Indoors: Approx. 12 to 15 meters / 39.3 to 49.2 feet  
Outdoors: Approx. 8 to 10 meters / 26.2 to 32.8 feet
- No. of transmissions: Approx. 1500 (without master unit firing)
- Controllable slaves: A, B, C (3 groups)
- Flash control: (1) E-TTL autoflash (with Type-A cameras)  
High-speed sync (FP flash) / FE lock / flash exposure compensation / FEB / flash ratio control  
(2) Manual flash (with Type A and B cameras)  
(3) Stroboscopic flash (with Type A and B cameras)
- Flash ratio control: A:B = 8:1 to 1:1 or 1:1 to 1:8 (In thirteen 1/2-stop increments)  
(For C, flash exposure compensation can be set up to ±3 stops in 1/3 or 1/2-stop increments.)
- Master flash:  
[Slave unit] ON/OFF possible (When ON, automatic set as slave unit A.)
- Reception angle: Horizontal: Approx. 80° / Vertical: Approx. 80°
- Flash coverage: Set automatically to **M** 24mm (Manual zooming of flash head also enabled)
- Flash-ready indication: AF-assist beam emitter blinks
- Flash modes: (1) Controlled automatically by master unit.  
(2) Manual flash and stroboscopic flash settable independently from master unit.
- Flash exposure compensation:  
Settable individually with each slave unit up to ±3 stops in 1/3- or 1/2-stop increments.
- Slave Operation Confirmation:  
Enabled with master unit's test firing button.

## Specifications

Slave unit SE mode cancellation: While the slave unit's SE mode is in effect, the slave unit turns on when a flash is fired.

The slave unit's SE mode can be canceled by the following wireless operations:

- (1) When the master unit's test firing button is pressed.
- (2) When the camera's FE lock button is pressed.

Power source: Internal power sources:

- (1) Size-AA alkaline batteries × 4
  - (2) Size-AA nickel-hydride batteries × 4
- \* Size-AA lithium batteries × 4

External power sources: (1) Compact Battery Pack CP-E2  
Size-AA alkaline batteries × 6  
Size-AA nickel-hydride batteries × 6

- (2) Transistor Pack E  
Battery Magazine TP with size-C alkaline batteries × 6  
Ni-Cd Pack TP (NR-SC Ni-Cd batteries × 6 in sealed pack)

SE mode: With the power switch set to SE, the Speedlite enters the SE mode as follows:

- On-camera master unit enters the SE mode after 90 sec. of non-use.
- Slave unit enters SE mode after 60 min. (or 10 min. with CF-4) of non-use.

Custom Functions:

Function	Custom Function No.	Setting	Description
FEB cancellation after completion	CF-1	0	Enabled
		1	Disabled
FEB sequence	CF-2	0	Correct exposure, decreased exposure, increased exposure.
		1	Decreased exposure, correct exposure, increased exposure.
Flash metering system	CF-3	0	E-TTL
		1	TTL
Slave unit SE mode activation	CF-4	0	Activate after 60 min. of non-operation.
		1	Activate after 10 min. of non-operation.
Slave unit SE mode cancellation	CF-5	0	Enable SE mode cancellation by master unit for 1 hour.
		1	Enable SE mode cancellation by master unit for 8 hours.
Modeling flash	CF-6	0	Enabled
		1	Disabled

Dimensions (mm) and Weight:

80 (W) x 138 (H) x 112 (D), 405 g  
3.1 (W) x 5.4 (H) x 4.4 (D) in, 14.2 oz

- All data are based on Canon's Standard Test Method.
- Subject to change without notice.



## ● Guide No.

[Normal Mode]

(At ISO 100 in meters)

Flash Coverage (mm)	17	24	28	35	50	70	80	105	
Normal (full) Flash Guide No.	15	28	30	36	42	46	50	55	
Quick Flash	Same as for manual flash from 1/2 to 1/6.								
Manual Flash Guide No.	1/1	15	28	30	36	42	46	50	55
	1/2	10.6	19.8	21.2	25.5	29.7	32.5	35.4	38.9
	1/4	7.5	14	15	18	21	23	25	27.5
	1/8	5.3	9.9	10.6	12.7	14.8	16.3	17.7	19.5
	1/16	3.8	7	7.5	9	10.5	11.5	12.5	13.8
	1/32	2.7	4.9	5.3	6.4	7.4	8.1	8.8	9.7
	1/64	1.9	3.5	3.8	4.5	5.3	5.8	6.3	6.9
	1/128	1.4	2.5	2.7	3.2	3.7	4.1	4.4	4.9

[High-Speed Sync (FP Flash) ]

Shutter Speed	Flash Coverage (mm)							
	17	24	28	35	50	70	80	105
1/125	10.6	19.8	21.2	25.2	29.7	32.5	35.4	38.9
1/160	9.4	17.5	18.8	22.5	26.3	28.8	31.3	34.4
1/180	8.8	16.5	17.7	21.2	24.7	27.1	29.5	32.4
1/250	7.5	14.0	15.0	18.0	21.0	23.0	25.0	27.5
1/320	6.6	12.4	13.3	15.9	18.6	20.3	22.1	24.3
1/350	6.3	11.8	12.7	15.2	17.7	19.4	21.1	23.2
1/400	5.9	11.1	11.9	14.2	16.6	18.2	19.8	21.7
1/500	5.3	9.9	10.6	12.7	14.8	16.3	17.7	19.4
1/640	4.7	8.8	9.4	11.3	13.1	14.4	15.6	17.2
1/750	4.3	8.1	8.7	10.4	12.1	13.3	14.4	15.9
1/800	4.2	7.8	8.4	10.1	11.7	12.9	14.0	15.4
1/1000	3.8	7.0	7.5	9.0	10.5	11.5	12.5	13.8
1/1250	3.4	6.3	6.7	8.0	9.4	10.3	11.2	12.3
1/1500	3.1	5.7	6.1	7.3	8.6	9.4	10.2	11.2
1/1600	3.0	5.5	5.9	7.1	8.3	9.1	9.9	10.9
1/2000	2.7	4.9	5.3	6.4	7.4	8.1	8.8	9.7
1/2500	2.4	4.4	4.7	5.7	6.6	7.3	7.9	8.7
1/3000	2.2	4.0	4.3	5.2	6.1	6.6	7.2	7.9
1/3200	2.1	3.9	4.2	5.0	5.9	6.4	7.0	7.7
1/4000	1.9	3.5	3.8	4.5	5.3	5.8	6.3	6.9
1/5000	1.7	3.1	3.4	4.0	4.7	5.1	5.6	6.1
1/6000	1.5	2.9	3.1	3.7	4.3	4.7	5.1	5.6
1/6400	1.5	2.8	3.0	3.6	4.2	4.5	4.9	5.4
1/8000	1.3	2.5	2.7	3.2	3.7	4.1	4.4	4.9

(Multiply by 3.3 to convert to feet)

## Specifications

### ● Maximum Continuous Flashes

Flash Output \ Hz	1	2	3	4	5	6	7	8	9	10
1/4	7	6	5	4	4	3	3	3	3	2
1/8	14	14	12	10	8	6	6	5	5	4
1/16	30	30	30	20	20	20	20	10	10	8
1/32	60	60	60	50	50	40	40	30	30	20
1/64	90	90	90	80	80	70	70	60	60	50
1/128	100	100	100	100	100	90	90	80	80	70

Flash Output \ Hz	11	12	13	14	15	16	17	18	19	20
1/4	2	2	2	2	2	2	2	2	2	2
1/8	4	4	4	4	4	4	4	4	4	4
1/16	8	8	8	8	8	8	8	8	8	8
1/32	20	20	20	20	18	18	18	18	18	16
1/64	40	40	40	40	35	35	35	35	35	30
1/128	70	60	60	60	50	50	50	50	50	40

Flash Output \ Hz	25	30	35	40	45	50	60	70	80	90	100
1/4	2	2	2	2	2	2	2	2	2	2	2
1/8	4	4	4	4	4	4	4	4	4	4	4
1/16	8	8	8	8	8	8	8	8	8	8	8
1/32	16	16	16	16	16	16	12	12	12	12	12
1/64	30	30	30	30	30	30	20	20	20	20	20
1/128	40	40	40	40	40	40	40	40	40	40	40

Flash Output \ Hz	11	12	13	14	15	16	17	18	19	20
1/4	2	2	2	2	2	2	2	2	2	2
1/8	4	4	4	4	4	4	4	4	4	4
1/16	8	8	8	8	8	8	8	8	8	8
1/32	12	12	12	12	12	12	12	12	12	12
1/64	20	20	20	20	20	20	20	20	20	20
1/128	40	40	40	40	40	40	40	40	40	40

- When the flash count is --, the maximum flash count will be as follows regardless of the flash frequency.

Flash Output	1/4	1/8	1/10	1/32	1/64	1/128
Flash Count	15	20	50	70	100	160

## ● AF-Assist Beam Emission Preconditions

550EX/Camera Combination	550EX's AF-Assist Beam Emitted	Camera's AF-Assist Beam Emitted
EOS-1D, EOS-1V, EOS-3, EOS-1N, EOS-1N RS, EOS D60, EOS D30, EOS ELAN 7/7E, 30/33, EOS 50/50 E/ELAN II/ELAN II E, EOS 300/REBEL 2000, EOS 500 N/REBEL G, EOS 3000N/66/REBEL XSN, EOS IX, EOS IX 7/IX Lite EOS 1000 N/REBEL II/1000 FN/REBEL S II, EOS 1000/REBEL/1000 F/REBEL S, EOS 100/ELAN, EOS 700, EOS RT, EOS-1, EOS 630/600, EOS 850, EOS 750, EOS 620, EOS 650	○	—
EOS 500/REBEL XS/REBEL X, EOS 5/A2/A2 E, EOS 10/10 S, EOS 5000/888	—	○

## ● Camera's Flash-Related Exposure Warnings

Mode	Warning Indication	Description	Remarks
Aperture-priority AE	Max. sync speed blinks.	The background will be overexposed.	Only the flash exposure setting for the subject is correct. Changing the aperture may stop the shutter speed from blinking.
Shutter speed-priority AE	Minimum aperture setting blinks.	The background will be overexposed.	Only the flash exposure setting for the subject is correct.
	Maximum aperture setting blinks.	The background will be underexposed.	
Program AE	Minimum aperture setting blinks.	The subject is too bright.	Attach a neutral-density filter to the lens to reduce the amount of light received by the camera.

## ● Speedlite 550EX Feature Availability

Camera	Camera's Max. Sync Speed (sec.)					Autoflash Control		Wireless Flash
	1/90	1/125	1/200	1/250	1/500	E-TTL	TTL	E-TTL
EOS 650		●				×	●	×
EOS 620				●		×	●	×
EOS 750		●				×	●	×
EOS 850		●				×	●	×
EOS 630/600		●				×	●	×
EOS-1				●		×	●	×
EOS RT		●				×	●	×
EOS 10S/10		●				×	●	×
EOS 700		●				×	●	×
EOS 1000/1000F/ REBEL/REBEL S	●					×	●	×
EOS 100/ELAN		●				×	●	×
EOS REBEL II/REBEL S II/ 1000N/1000FN	●					×	●	×
EOS 5/A2/A2E			●			×	●	×
EOS 500/REBEL X/REBEL XS	●					×	●	×
EOS-1N/1N RS				●		×	●	×
EOS 5000/888	●					×	●	×
EOS 50/50E/ELAN II/ELAN II E		●				●	●*1	●*2
EOS REBEL G/500 N	●					●	●*1	●*2
EOS IX			●			●	●*1	●*2
EOS IX 7/IX Lite		●				●	●*1	●*2
EOS-3			●			●	●*1	●
EOS 3000/88	●					×	●	×
EOS 300/REBEL 2000	●					●	●*1	●*2
EOS-1V				●		●	●*1	●
EOS ELAN 7/7E/30/33		●				●	●*1	●
EOS D30/D60			●			●	×	●
EOS 3000N/66/REBEL XSN	●					●	●*1	●*2
EOS-1D					●	●	×	●

\*1 With Custom Function CF-3-1.

\*2 Only one slave group can be controlled.

\*3 For bulb exposures with the EOS 700, the aperture f/5.6.



---

This device complies with Part 15 of the FCC Rules. Operation is subject to the following two conditions: (1) This device may not cause harmful interference, and (2) this device must accept any interference received, including interference that may cause undesired operation.

Do not make any changes or modifications to the equipment unless otherwise specified in the instructions. If such changes or modifications should be made, you could be required to stop operation of the equipment.

This equipment has been tested and found to comply with the limits for a class B digital device, pursuant to part 15 of the FCC Rules. These limits are designed to provide reasonable protection against harmful interference in a residential installation. This equipment generates, uses and can radiate radio frequency energy and, if not installed and used in accordance with the instructions, may cause harmful interference to radio communications.

However, there is no guarantee that interference will not occur in a particular installation. If this equipment does cause harmful interference to radio or television reception, which can be determined by turning the equipment off and on, the user is encouraged to try to correct the interference by one or more of the following measures:

- Reorient or relocate the receiving antenna.
- Increase the separation between the equipment and receiver.
- Consult the dealer or an experienced radio/TV technician for help.

This digital apparatus does not exceed the Class B limits for radio noise emissions from digital apparatus as set out in the interference-causing equipment standard entitled "Digital Apparatus", ICES-003 of the Industry Canada.



The CE Mark is a Directive conformity mark of the European Community (EC)

The apparatus shall not be exposed to dripping or splashing.  
Batteries shall not be exposed to excessive heat such as sunshine, fire or the like.  
Dry batteries shall not be subjected to charging.

# Canon

**CANON INC.** 30-2, Shimomaruko 3-chome, Ohta-ku, Tokyo 146-8501, Japan

**U.S.A. ——— CANON U.S.A. INC.**

For all inquiries concerning this camera, call toll free in the U.S.  
1-800-OK-CANON or write to: Customer Relations, Canon U.S.A., Inc.  
One Canon Plaza, Lake Success, N.Y. 11042-1198

**CANADA ——— CANON CANADA INC. HEADQUARTERS**

6390 Dixie Road, Mississauga, Ontario L5T 1P7, Canada  
**CANON CANADA INC. MONTREAL BRANCH**  
5990, Côte-de-Liesse, Montréal Québec H4T 1V7, Canada

**CANON CANADA INC. CALGARY OFFICE**

2828, 16th Street, N.E. Calgary, Alberta T2E 7K7, Canada  
For all inquiries concerning this camera, call toll free in Canada  
1-800-OK-CANON

**EUROPE, ——— CANON EUROPA N.V.**

**AFRICA & MIDDLE EAST** Bovenkerkerweg 59-61, P.O. Box 2262, 1180 EG Amstelveen, The Netherlands

**CANON COMMUNICATION & IMAGE FRANCE S.A.**

102, Avenue du Général de Gaulle 92257 La Garenne-Colombes Cedex, France  
**CANON UK LTD.**

Woodhatch Reigate Surrey RH2 8BF, United Kingdom

**CANON DEUTSCHLAND GmbH**

Europark Fichtenhain A10, 47807 Krefeld, Germany

**CANON ITALIA S.p.A.**

Palazzo L, Strada 6, 20089 Rozzano, Milanofiori, Milano, Italy

**CANON Benelux N.V./S.A.**

Bessenveldstraat 7, 1831 Diegem (Machelen), Belgium

**CANON Schweiz AG**

Geschäftsbereich Wiederverkauf, Industriestrasse 12, CH-8305 Dietlikon, Switzerland

**CANON G. m. b. H.**

Oberlaaerstrasse 233, 4th floor, 1100 Wien, Austria

**CANON España, S. A.**

C/Joaquín Costa, 41, 28002 Madrid, Spain

**SEQUE Soc. Nac. de Equip., Lda.,**

Praça da Alegria, 58, 2º, 1269-149 Lisboa, Portugal

**CENTRAL & SOUTH AMERICA ——— CANON LATIN AMERICA, INC. DEPTO DE VENTAS**

703 Waterford Way Suite 400 Miami, FL 33126 U.S.A.

**CANON LATIN AMERICA, INC. CENTRO DE SERVICIO Y REPARACION**

Apartado 2019, Zona Libre de Colón, República de Panamá

**ASIA ——— CANON HONGKONG CO., LTD.**

9/F, The Hong Kong Club Building, 3A Chater Road, Central, Hong Kong

**CANON SINGAPORE PTE. LTD.**

79 Anson Road #09-01/06 Singapore 079906

**OCEANIA ——— CANON AUSTRALIA PTY. LTD.**

1 Thomas Holt Drive, North Ryde, N.S.W. 2113, Australia

**CANON NEW ZEALAND LTD.**

Fred Thomas Drive, P.O. Box 33-336, Takapuna, Auckland, New Zealand

**JAPAN ——— CANON SALES CO., INC.**

12-15 Mita, 3-Chome, Minato-ku, Tokyo 108-8011, Japan

This Instructions booklet is dated April 2000. For information on the camera's compatibility with system accessories marketed after this date, contact your nearest Canon Service Center.